

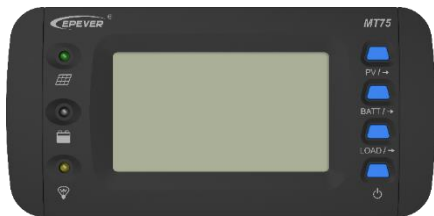

# Remote Meter

---

## USER MANUAL



MT75



## Contents

1. Safety Instructions .....	1
2. Overview .....	2
3. Appearance .....	3
4. Accessories .....	5
5. Installation Instructions .....	6
6. Indicator Instruction .....	8
7. Button Instruction.....	9
8. LCD Display .....	10
9. Error Codes.....	12
10. Specifications .....	14
11. Dimension .....	16
12. Recommended Applications.....	17
12.1 Standard Application.....	17
12.2 Upgrade Application .....	18
12.3 Advanced Application .....	19
12.4 Pro. Application .....	20



# 1. Safety Instructions

- Please keep this manual for future reference.
- Please read this manual and safety information carefully before using the product.
- Keep the product away from rain, exposure, severe dust, vibration, corrosion, and intense electromagnetic interference.
- Please avoid water, and other liquids enter into the product.
- There are no user-serviceable parts inside the product. Do not disassemble or attempt to repair it.

## 2. Overview

MT75 is a new generation of remote meters that can monitor the EPEVER solar charge controller and inverter on one screen simultaneously. This product provides multiple solutions to fit different requirements from off-grid users.

### Features:

- Dual RJ45 communication ports
- 4.7-inch LCD screen, real-time dynamic display of system data
- Visually error codes, timely notification of warnings and faults
- Load ON/OFF button to control the load output directly
- Dry contact output and enable switch design
- Remote control inverter ON or OFF
- Friendly connect with different EPEVER devices

### 3. Appearance

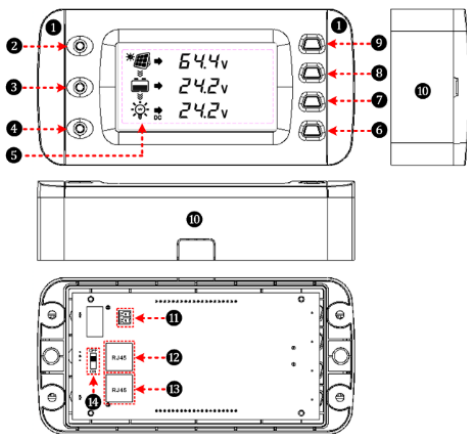

①	Decorative shell	⑧	Battery parameter button
②	PV indicator	⑨	PV parameter button
③	Battery indicator	⑩	Base (optional)
④	Load indicator	⑪	Dry contact interface <sup>①</sup>
⑤	LCD	⑫	RS485 port 1(RJ45)
⑥	Load ON/OFF button	⑬	RS485 port 2(RJ45)
⑦	Load parameter button	⑭	Dry contact enable switch <sup>①</sup>

① **Working Principle:**

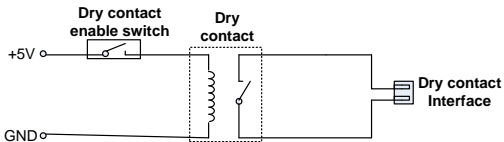

Dry contact rated value: 5A/30VDC; Max. value: 0.5A/60VDC

**Note:** Turn the dry contact enable switch ⑭ to ON only when the dry contact is used, and turn it OFF when not used to save the dry contact's loss.



## 4. Accessories

Category	Name	Number/Model	Purpose
Included	2P-3.81 plug	2 pcs	Connect to the 3.81 pins remote control switch of inverter
	RS485 cable	2 pcs/CC-RS485-RS485-200U	Connect the MT75 to the RJ45 port of the controller or inverter
	MT75 base	1 pcs	Used for wall installation
Optional	RS485 cable	CC-RS485-RS485-50/100/200/300/500/1000U (0.5/1/2/3/5/10 meter)	Connect the MT75 to the RJ45 port of the controller or inverter
	USB cable	USB-RS485-200U	Connect the MT75 to the PC
	3.81-RS485 cable	3.81-RS485-200U	Connect the MT75 to the iTracer-AD series and the iTracer-ND series controllers
	Dry contact interface cable	C-2P3.81-2P3.81-50/100/200/300/500/1000U (0.5/1/2/3/5/10 meter)	Connect the 3.81 plug

## 5. Installation Instructions

### ● Before Installation

1. Check whether the solar controller's ID is 1; if not, set it to 1.
2. Check whether the ID of the inverter is 3; if not, please set it to 3.
3. Wall installation or surface mounting installation is optional.

### ● Wall Installation

Step 1: Locate and drill screw holes based on the frame mounting dimension (175x50mm), and erect the plastic expansion bolts.

Step 2: Use four M5 self-tapping screws to fix the frame.

Step 3: Remove the decorative shell.

Step 4: Use two M4 pan head screws to mount the MT75 surface on the base.

Step 5: Install the decorative shell.

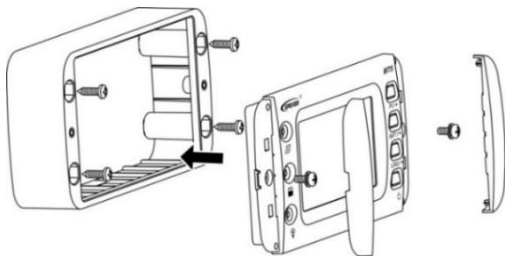

### ● Surface Mounting Installation

Step 1: Locate based on the installation size (176mm) and drill screw holes (no smaller than 158.2x85.2mm).



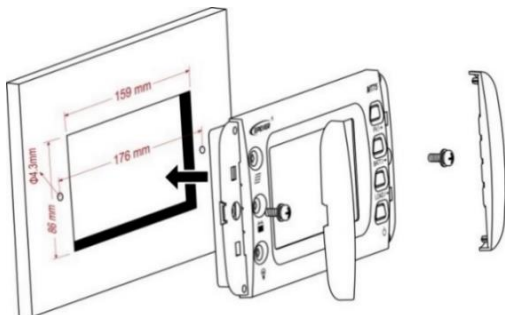

Step 2: Remove the decorative shell.

Step 3: Use two M4 pan head screws to fix MT75.





Step 4: Install the decorative shell.



## 6. Indicator Instruction

Indicator	Color	Status	Instruction
	Green	ON solid	PV is charging
	Green	OFF	No PV charge
	Green	Fast flashing	PV overvoltage
	Green	ON solid	Battery normal
	Green	Fast flashing	Battery overvoltage
	Orange	ON solid	Battery under voltage
	Red	ON solid	Battery over-discharge
	Red	Slow flashing	Battery over temperature Battery under temperature Controller over temperature
	Green	ON solid	Load switch ON
	Green	OFF	Load switch OFF
	Green	Fast flashing	System voltage error
	Orange	Fast flashing	

## 7. Button Instruction

Button	Operation	Instruction
	Click	Display PV parameters in cycle
	Click	Display battery parameter in cycle
	Click	Display load parameter in cycle Exit the fault page
	Press for 5S	Check error code information
	Click	Control the switch of solar controller and inverter in sync <sup>①</sup>
	Press for 5S	Clear the total of PV generated power, total DC load usage, and total AC load usage

- ① When the solar controller and inverter's output is out of sync, click to turn off all the loads' output simultaneously, click again to turn on all the load outputs.

## 8. LCD Display



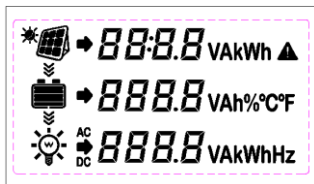









- LCD Display



Symbol	Definition	Symbol	Definition
	PV charging		PV no charge
	Load ON		Load OFF

- LCD Display Interface









Item	LCD Display	Definition
PV	→ 64.4v	PV voltage
	→ 3.3 A	PV current
	→ 0.2 kW	PV power
	→ 0.6 kWh	Total PV generated power <sup>①</sup>
Battery	→ 24.0v	Battery voltage

	 → <b>11.1</b> A	Battery current
	 → <b>35.0</b> %	Battery capacity
	 → <b>25.0</b> °C	Battery temperature
DC Load	 → <b>25.3</b> V DC	DC load voltage
	 → <b>4.9</b> A DC	DC load current
	 → <b>0.1</b> kW DC	DC load power
	 → <b>0.1</b> kWh DC	Total DC load usage <sup>①</sup>
AC Load	 → <b>219.9</b> V AC	AC load voltage
	 → <b>1.7</b> A AC	AC load current
	 → <b>0.3</b> kW AC	AC load power
	 → <b>0.3</b> kWh AC	Total AC load usage <sup>②</sup>
	 → <b>50.0</b> Hz AC	AC load frequency

- ① The "Total PV generated power" and "Total DC load usage" is the solar controller's parameter, which can be directly read and displayed by the MT75.
- ② The "Total AC load usage" is calculated based on the inverter's AC load power and displayed on the MT75.

## 9. Error Codes

- Solar Controller Error Codes

Indicator	Color	Status	LCD	Code
	Green	Fast flashing	<i>Err</i> ▲ <i>1001</i>	Battery over voltage
	Orange	On solid	—	Battery under voltage
	Red	On solid	<i>Err</i> ▲ <i>1002</i>	Battery over-discharge
	Red	Slow flashing	<i>Err</i> ▲ <i>1003</i>	Battery over temperature
			<i>Err</i> ▲ <i>1004</i>	Battery under temperature
			<i>Err</i> ▲ <i>1005</i>	Controller over temperature
	Orange	Fast flashing	<i>Err</i> ▲ <i>1006</i>	System voltage error
	Green	Fast flashing		
	Green	Fast flashing	<i>Err</i> ▲ <i>1007</i>	PV overvoltage
	Green	Slow flashing	<i>Err</i> ▲ <i>1008</i>	Load short circuit
	Green	Slow flashing	<i>Err</i> ▲ <i>1009</i>	Overload

**Note:** When the battery voltage is equal to the low voltage disconnect voltage (LVD) point of the controller, the controller and inverter's output will be turned off.



- Inverter Error Codes

Indicator	Color	Status	LCD	Code
	Green	Slow flashing	<i>Err</i> ▲ <i>3001</i>	Output short circuit
			<i>Err</i> ▲ <i>3002</i>	Output overload
			<i>Err</i> ▲ <i>3003</i>	Output voltage abnormal
			<i>Err</i> ▲ <i>3004</i>	Busbar overvoltage
			<i>Err</i> ▲ <i>3005</i>	Input overvoltage
			<i>Err</i> ▲ <i>3006</i>	Input under-voltage
			<i>Err</i> ▲ <i>3007</i>	Input over-current
			<i>Err</i> ▲ <i>3008</i>	Inverter over temperature

## 10. Specifications

Model	MT75	
Compatible products	Controller	XTRA-N series/TRIRON series/ Tracer-AN series/Tracer-BN series Note: Required cables for the above products are shipped with MT75.
		iTracer-AD series/iTracer-ND series Note: Required cables for the above products need additional purchase.
	Inverter	IPower series(1kw or above, suitable for application 1/3)/IPower-Plus series/ NPower series/SHI series
Input power	5VDC(Power supply by the connected controller or inverter)	
LCD visual angle	12' clock	
LCD backlight	Yes	
Installation methods	Wall installation Surface mounting installation	
Self-consumption	14mA/5V(no backlight) 26mA/5V(backlight)	
Max. power consumption	100mA/5V(Backligh+dry contact)	

Working temperature	-20°C ~ +65°C
Storage temperature	-20°C ~ +80°C
Dimension	193×95×48mm (base) 193×95×23mm (no base)
Mounting size	175×50mm(base) 176mm(no base)
Mounting hole size	φ 5mm(base) φ4.3mm(no base)
Net Weight	0.29Kg(base) 0.22Kg(no base)

# 11. Dimension

Dimension without base

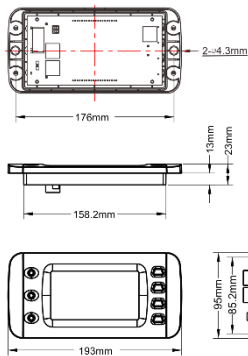

Dimension with base

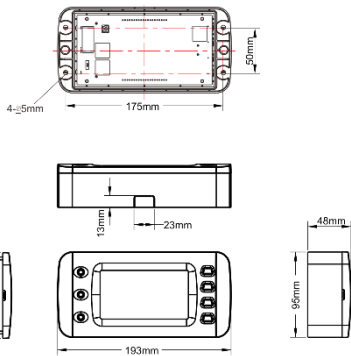

## 12. Recommended Applications

### 12.1 Standard Application

#### 1) Advantages

MT75 monitors the solar controller and inverter's operational status while controlling the AC load and DC load output by the *Load ON/OFF* button directly.

#### 2) Connection Diagram

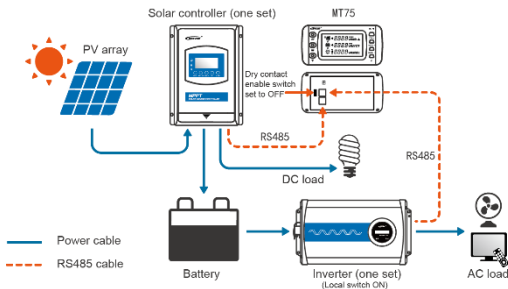

No.	Item	Number
1	Solar controller	1 pcs
2	Inverter	1 pcs
3	MT75	1 pcs
4	RS485 cable(Included)	2 pcs
5	PV, battery, AC load, DC load	According to actual needs

#### 3) Operations

1. Connect the RS485 ports of MT75 to the controller and inverter.
2. Set MT75's dry contact enable switch to OFF state.
3. Must set inverter switch to ON state.

4. MT75 load ON/OFF button directly controls the AC and DC load output.

## 12.2 Upgrade Application

### 1) Advantages

MT75 monitors the operational status and error codes of the solar controller and inverter at the same time. The *Load ON/OFF* button controls the inverter start or stop, effectively reducing the inverter's loss and extending the system's lifetime.

### 2) Connection Diagram

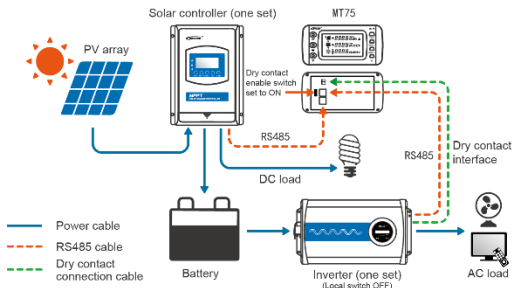

No.	Item	Number
1	Solar controller	1 pcs
2	Inverter	1 pcs
3	MT75	1 pcs
4	RS485 cable(Included)	2 pcs
5	Dry contact connection cable(Optional)	1 pcs
6	PV, battery, AC load, DC load	According to actual needs

### 3) Operations

1. Connect the RS485 ports of MT75 to the controller and inverter.
2. Connect the MT75's dry contact interface to the inverter's external switch port.
3. Set MT75's dry contact enable switch to ON state.
4. Set inverter switch to OFF state.
5. MT75 load ON/OFF button controls the inverter start or stop remotely.

## 12.3 Advanced Application

### 1) Advantages

With the RS485-1M2S module, the MT75 can monitor the operational status of the solar controller and inverter. Still, it also can connect with an external WIFI module, BT module, or USB cable. The phone APP or PC software can perform the parameter settings and operational status monitoring. MT75 can also control the output of AC and DC loads by the *Load ON/OFF* button.

### 2) Connection Diagram

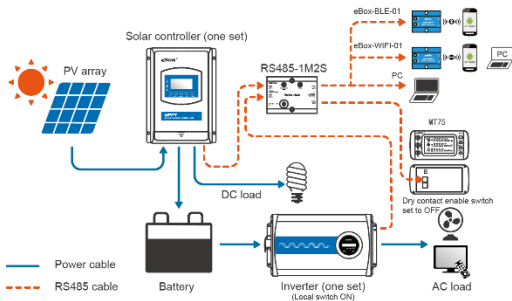

No.	Item	Number
1	Solar controller	1 pcs
2	Inverter	1 pcs

3	MT75	1 pcs
4	RS485-1M2S module	1 pcs
5	WIFI, BT module, or USB cable	1 pcs
6	Mobile phone or PC	1 pcs
7	RS485 cable	4 pcs (2 pcs included, 2 pcs optional )
8	PV, battery, AC load, DC load	According to actual needs

### 3) Operations

1. Connect the main port of RS485-1M2S to controller and inverter.
2. Connect the slave port of RS485-1M2S to MT75 and WIFI module, BT module, or USB cable.
3. Set MT75's dry contact enable switch to OFF state.
4. Must set inverter switch to ON state.
5. Set the parameters or monitor the operational status by the phone APP or PC software.
6. MT75 load ON/OFF button directly controls the AC and DC load output.

## 12.4 Pro. Application

### 1) Advantages

With the RS485-1M2S module, the MT75 can monitor the operational status of the solar controller and inverter. Still, it also can connect with an external WIFI module, BT module, or USB cable. The phone APP or PC software can perform the parameter settings and operational status monitoring. MT75 can also remotely control the inverter start or stop, which effectively prolongs the system's lifetime.

### 2) Connection Diagram



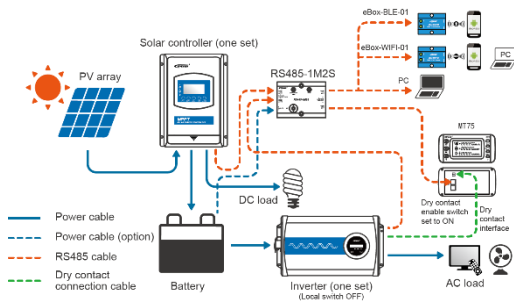

No.	Item	Number
1	Solar controller	1 pcs
2	Inverter	1 pcs
3	MT75	1 pcs
4	RS485-1M2S module	1 pcs
5	WIFI module, BT module, or USB cable	1 pcs
6	Mobile phone or PC	1 pcs
7	RS485 cable(Included)	4 pcs (2 pcs included, 2 pcs optional )
8	Dry contact connection cable(Optional)	1 pcs
9	Power cable	1 pcs
10	PV, battery, AC load, DC load	According to actual needs

### 3) Operations

1. Connect the main port of RS485-1M2S to controller and inverter.
2. Connect the slave port of RS485-1M2S to MT75 and

WIFI/BT/USB cable.

3. Connect the MT75's dry contact interface to the inverter's external switch port.
4. Set MT75's dry contact enable switch to ON state.
5. Set inverter switch to OFF state.
6. Set the parameters or monitor the operational status by the phone APP or PC software.
7. MT75 load ON/OFF button controls inverter start or stop remotely.

**Any changes without prior notice!**

Version number: V2.0



**HUIZHOU EPEVER TECHNOLOGY CO., LTD.**

**Beijing Tel: +86-10-82894896/82894112**

**Huizhou Tel: +86-752-3889706**

**E-mail: [info@epsolarpv.com](mailto:info@epsolarpv.com)**

**Website: [www.epsolarpv.com](http://www.epsolarpv.com)**

**[www.epever.com](http://www.epever.com)**