



Inverter/Charger

User Manual



UP2000-HM6021 / UP2000-HM6022

UP3000-HM5041 / UP3000-HM5042

UP3000-HM8041 / UP5000-HM8042

UP3000-HM10021 / UP3000-HM10022

Contents

Safety Instructions.....	1
1 General Information.....	4
1.1 Overview	4
1.2 Identification of parts	5
1.3 Naming rules	8
1.4 Connection diagram	8
2 Installation Instructions.....	9
2.1 General installation notes.....	9
2.2 Before installation.....	10
2.2.1 Check the pack list.....	10
2.2.2 Prepare modules.....	10
2.3 Determine the installation position	13
2.4 Install the inverter/charger.....	14
2.5 Wiring	15
2.6 Operating the inverter/charger	21
3 Interface	22
3.1 Indicator.....	22
3.2 Button	23
3.3 LCD	24
3.4 Operating mode.....	26
3.5 Settings	36
3.6 Battery voltage customized logic.....	46
3.7 Battery discharge current limit.....	48
4 Protections	49
5 Troubleshooting.....	50
5.1 Error codes.....	50
5.2 Solutions.....	51
6 Maintenance.....	52
7 Specifications	53
8 Appendix 1 Disclaimers	57

Safety Instructions





Please reserve this manual for future review.

This manual contains all the instructions for safety, installation, and operation of the UPower-Hi series inverter/charger (below referred to as the inverter/charger).





1. Explanation of symbols

Please read related literature accompanying the following symbols to enable users to use the product efficiently and ensure personal and property safety.

The entire system should be installed by professional and technical personnel.

Symbol	Definition
TIP	Indicates any practical advice for reference.
	IMPORTANT: Indicates a critical tip during the operation, if ignored, may cause the device to run in error.
	CAUTION: Indicates potential hazards, if not avoided, may cause the device damaged.
	WARNING: Indicates the danger of electric shock, if not avoided, would cause casualties.
	WARNING HOT SURFACE: Indicates the risk of high temperature, if not avoided, would cause scalds.
	Read the user manual carefully before any operation.

Symbols of the inverter/charger

		This symbol indicates that after disconnecting the inverter from the grid and battery bank, you should wait for ten minutes before touching the internal conductive devices.
		Read the instructions before performing any operation on the inverter.
		Danger! Electric Shock Risk! There are live devices here, only professional and qualified personnel can install and operate it.

2. Requirements for professional and technical personnel

- Professionally trained;
- Familiar with related safety specification for the electrical system;
- Read this manual carefully and master related safety cautions.

3. Professional and technical personnel is allowed to do

- Install the inverter/charger to a specified location;
- Conduct trial operations for the inverter/charger;
- Operate and maintain the inverter/charger.

4. Safety cautions before installation

- When you receive the inverter/charger, check whether there is any damage that occurred in transportation. Contact the transportation company or our company in time for any problem.
- When storing or moving the inverter/charger, follow the instructions in the manual.
- When installing the inverter/charger, you must evaluate whether the operation area exists any arc danger.
- Do not store the inverter/charger where children can touch it.
- The inverter/charger is off-grid type. Therefore, the AC output is strictly prohibited from being connected to the grid; otherwise, the inverter/charger would be damaged.
- The inverter/charger is only allowed for stand-alone operation. Connecting multiple units' output in parallel or series would damage the inverter/charger.

5. Safety cautions for mechanical installation

- Before installation, make sure the inverter/charger has no electrical connection.
- Ensure the inverter/charger installation's heat dissipation space. Do not install the inverter/charger in humid, greasy, flammable, explosive, dust accumulative, or other severe environments.

6. Safety cautions for electrical connection

- Check if all the wiring connections are tight to avoid the danger of heat accumulation due to a loose connection.
- The protective grounding must be connected to the ground. The cross-section of the wire should not be less than 4mm².
- A circuit breaker should be used between the battery and the inverter/charger; the circuit breaker's value should be twice the inverter/charger rated input current.
- DO NOT put the inverter/charger close to the flooded lead-acid battery because the terminals' sparkle may ignite the hydrogen released by the battery.
- The AC output port is only connected to the load. Therefore, it is strictly forbidden to connect other power sources or utilities. Otherwise, the damage will be caused to the inverter/charger. Also, turn off the inverter/charger before any installation.
- Both utility input and AC output are of high voltage, do not touch the wiring connection to avoid electric shock.

7. Safety cautions for inverter/charger operation:

- When the inverter/charger is working, its heat sink and casing will generate a lot of heat; the

temperature would be very high. Please do not touch it.

- When the inverter/charger is working, please do not open the inverter/charger cabinet to operate.
- When eliminating the faults or disconnecting the DC input, turning off the inverter/charger's switch, then carry out the operation after the LCD screen is completely OFF.

8. The dangerous operations which would cause electric arc, fire, or explosion:

- Touch the wire end that hasn't been insulation treated and maybe electriferous.
- Touch the wiring copper row or internal devices that may be electriferous.
- The power cable connection is loose.
- Screw or other spare parts inadvertently falls into the inverter/charger.
- **Incorrect operations are carried by untrained non-professional, or technical personnel.**



WARNING

Once an accident occurs, it must be handled by professional and technical personnel. Improper operations would cause more serious accidents.

9. Safety cautions for stopping the inverter/charger

- Firstly turn off the breakers on the utility input side and AC output side, then turn off the DC switch;
- After the inverter/charger stops for ten minutes, the internal conductive devices could be touched;
- The inverter/charger can be restarted after removing the faults which may affect its safety performance;
- No maintenance parts in the inverter/charger. If any maintenance service is required, please contact our after-sales service personnel.



WARNING

Do NOT touch or open the shell after the inverter is powered off within ten minutes.

10. Safety cautions for inverter/charger maintenance:

- Testing equipment is recommended to check the inverter/charger to make sure there is no voltage or current;
- When conducting electrical connection and maintenance work, must post temporary warning sign or put up barriers to prevent unrelated personnel from entering the electrical connection or maintenance area;
- Improper maintenance operation to the inverter/charger may cause personal injury or equipment damage;
- **Wear an antistatic wrist strap, or avoid unnecessary contact with the circuit board.**



CAUTION

The safety mark, warning label, and nameplate on the inverter/charger should be visible, not removed, or covered.

1 General Information

1.1 Overview

UPower-Hi, an upgrade hybrid inverter charger, supports utility charging, oil generator charging, solar charging, utility output, inverter output, and energy management. The DSP chip in the product with an advanced control algorithm brings high response speed and high conversion efficiency. In addition, this product adopts an industrial design to ensure high reliability and features multiple charging and output modes.

The new optimized MPPT charging technology fastly tracks the solar panels' max power point in any situation and obtains the maximum energy in real-time.

The AC to DC charging process adopts the advanced control algorithm to realize a full digital PFC and dual closed-loop control of voltage and current. As a result, the DC output charging voltage and current are continuously adjustable within a specific range.

The DC to AC inverting process, based on a fully smart digital design, adopts advanced SPWM technology to get a pure sine wave output. The inverting process converts the DC power to AC power, suitable for household appliances, power tools, industrial equipment, audio systems, and other electronics.

The 4.2-inch LCD shows the operational status and full parameters.

To maximize solar energy utilization, users can choose energy sources according to actual needs and flexibly take the utility as a supplement. This inverter charger can increase the system's power supply guarantee rate, which is suitable for solar energy, utility/oil generator hybrid systems. It aims to provide users with high-quality, high-stability, and high-reliability electrical energy.

Features

- Full intelligent digital energy storage equipment
- Supports the battery mode or non-battery mode
- Non-battery mode: charging with solar (Main) and utility (Assist) simultaneously
- Surge and reverse connection protections to support the lithium battery system perfectly
- Advanced SPWM technology and pure sine wave output
- PFC technology achieves a high power factor of AC to DC charging and reduces grid capacity usage
- Full digital double closed-loop control
- High tracking efficiency of MPPT no less than 99.5%
- Three charging modes: Solar only, Solar priority, Utility & Solar
- Two AC output modes: Utility priority and Inverter priority

- Self-learning SOC display function
- Multiple LED indicators to dynamic display the status
- AC OUT button to control the AC output directly
- 4.2 inch LCD to monitor and modify system parameters
- Remote temperature compensation for batteries
- Optional WiFi or GPRS Remote control by the RS485 isolated com. port
- Optional BMS-Link port, taking the charging and discharging control from BMS
- Customized charging current and discharging limited current
- Supports cold start and soft start
- Comprehensive electronic protection features

1.2 Identification of parts

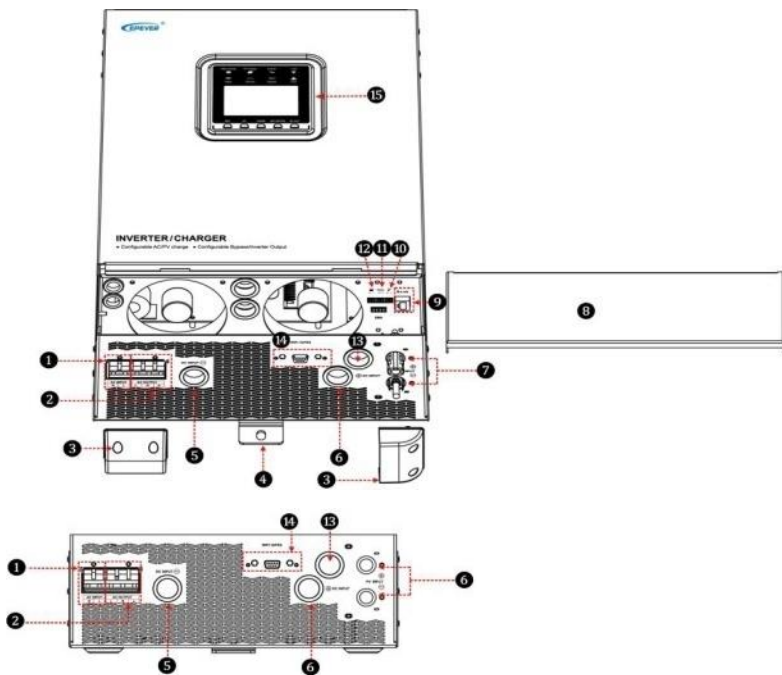

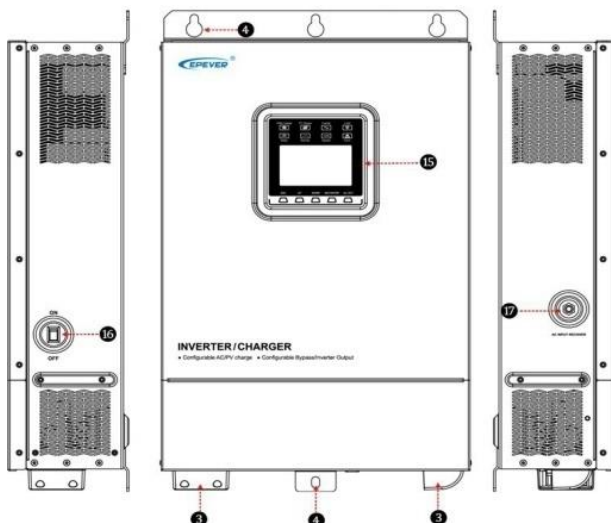

①	Utility input terminal	⑩	RTS interface
②	AC output terminal	⑪	Dry contact interface ^②
③	Terminal covers	⑫	RBVS interface
④	Mounting holes (4 Total)	⑬	Cable hole
⑤	Battery negative input terminal	⑭	RS485 interface(DB9 female, with isolation design) ^③ 5VDC/200mA
⑥	Battery positive input terminal		
⑦	PV input terminal (MC4)	⑮	LCD
⑧	External cover	⑯	Power switch
⑨	BMS-Link connection port(RJ45, without isolation design) ^①	⑰	Utility overcurrent protector

① BMS-Link connection port (RJ45)

+ Function:

Through a BMS-Link converter, different lithium battery manufacturers' BMS protocols can be converted into our company's standard BMS protocol. In addition, it realizes the communication between the inverter/charger and the BMS.

+ RJ45 pin definition:

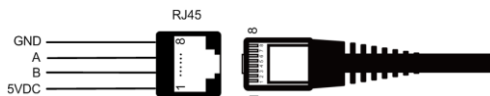

Pin	Definition	Pin	Definition
1	5VDC	5	RS-485-A
2	5VDC	6	RS-485-A
3	RS-485-B	7	GND
4	RS-485-B	8	GND



CAUTION

Please refer to the "BMS Lithium Battery Protocols & Fixed ID Table" or contact our technical supporters for the currently supported BMS manufacturers and the BMS parameters.

② Dry contact interface

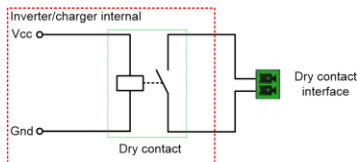

+ Working principle:

When the battery voltage reaches the dry contact ON voltage(DON), the dry contact is connected. Its coil is energized. The dry contact can drive resistive loads of no more than 125VAC /1A, 30VDC/1A. According to different battery types of the inverter charger, the default values of the dry contact ON(DON) voltage and the dry contact OFF(DOF) voltage are different. Please refer to the chapter [3.5 Settings](#) > item [19 DON](#) and item [20 DOF](#) for details.

③ RS485 interface (DB9 female)

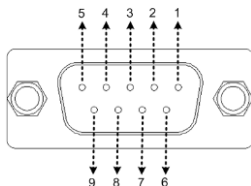

DB9 pin definition for base UP-Hi series:

Pin	Definition	Pin	Definition
1-4	NC	7	RS-485-A
5	GND	8	RS-485-B
6	NC	9	5VDC

DB9 pin definition for RTU-type UP-Hi series:

Pin	Definition	Pin	Definition
1-2	NC	6	NC

3	12VDC	7	RS-485-A
4	GND2(12VDC power ground)	8	RS-485-B
5	GND1(5VDC power ground)	9	5VDC

1.3 Naming rules

UP 5000 - H M 80 4 2 (RTU)

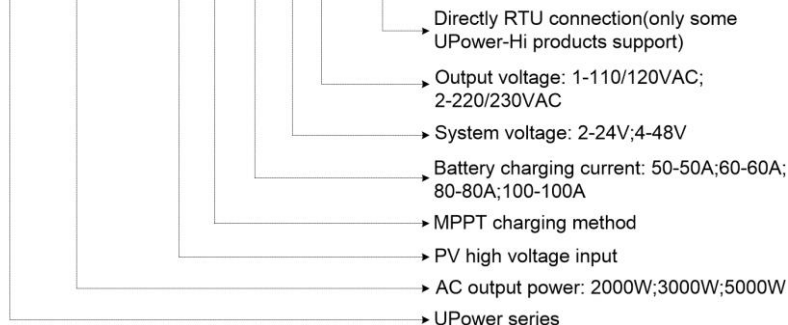

1.4 Connection diagram

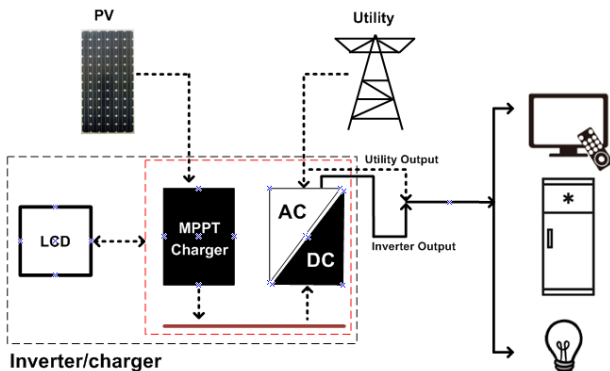

- No battery mode

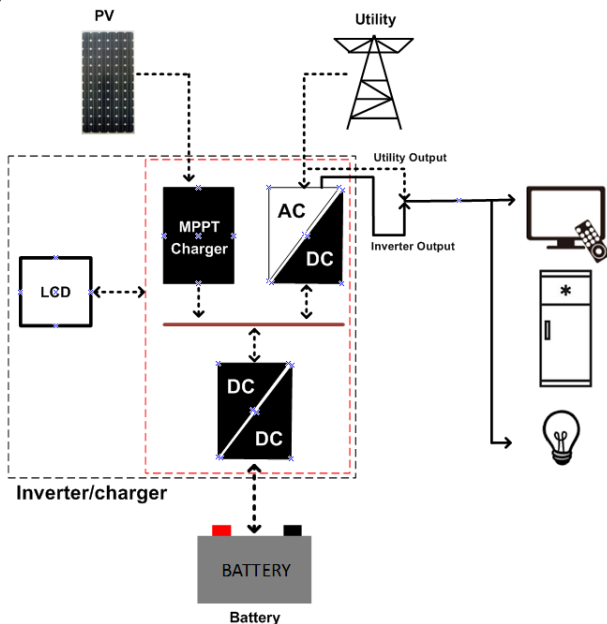

- **Battery mode**



Supported battery types: AGM、GEL、FLD、LFP8/LFP15/LFP16、LNCM7/LNCM14

 WARNING	<p>AC loads shall be determined according to the output power of the inverter/charger. The load exceeding the maximum output power may damage the inverter/charger.</p>
 CAUTION	<ul style="list-style-type: none"> • For different battery types, confirm the relevant parameters before power on. • No-battery mode and battery mode can set by setting item 0.

2 Installation Instructions

2.1 General installation notes

- Read all the installation instructions carefully in the manual before installation.
- Be very careful when installing the batteries. Please wear eye protection when installing the open-type lead-acid battery, and rinse with clean water in time for battery acid contact.
- Keep the battery away from any metal objects, which may cause a short circuit of the battery.
- Acid gas may be generated when the battery is charged. Ensure that the surrounding environment is well ventilated.

- The inverter/charger requires enough clearance above and below for proper airflow. Do not install the inverter/charger and the lead-acid liquid battery in the same cabinet to avoid the batteries' acid gas from corroding the inverter/charger.
- Only charge the batteries within the control range of this inverter/charger.
- Loose power connections and corroded wires may result in high heat that can melt wire insulation, burn surrounding materials, or even cause a fire. Ensure tight connections and secure cables with clamps to prevent them from swaying while moving the inverter/charger.
- Select the system cables according to the current density of not more than $3.5A/mm^2$ (according to the National Electrical Code Article 690 NFPA70.)
- Avoid direct sunlight and rain infiltration when installing it outdoor.
- After turn off the power switch, there is still high voltage inside the inverter/charger. Therefore, do not open or touch the internal components and perform related operations after the capacitor's total discharge.
- Do not install the inverter/charger in a harsh environment such as humid, greasy, flammable, explosive, or dust accumulation.
- The DC input terminal is equipped with reverse polarity protection. Therefore, the reverse connection of the DC input terminal will not cause fatal damage to the product. However, it is strongly recommended to connect the inverter/charger with the PV array and utility after normal running.
- Both utility input and AC output are of high voltage, do not touch the wiring connection to avoid electric shock.
- To prevent injury, do not touch the fan while it is working.

2.2 Before installation

2.2.1 Check the pack list

- Inverter/charger 1 pcs
- User manual 1ps
- Included accessories 1pcs(Details refer to the "Accessories list" file shipped with the inverter/charger.)

2.2.2 Prepare modules

1) Battery

- **Recommended wire size of the battery and the circuit breaker is as below.**

Model	Battery wire size	Circuit breaker	Ring terminal
UP2000-HM6021	20mm ² /4AWG	2P—125A	RNB38-8S
UP2000-HM6022	20mm ² /4AWG	2P—125A	RNB38-8S

UP3000-HM5041	16mm ² /5AWG	2P—100A	RNB22-8
UP3000-HM5042	16mm ² /5AWG	2P—100A	RNB22-8
UP3000-HM8041	16mm ² /5AWG	2P—100A	RNB22-8
UP3000-HM10021	35mm ² /1AWG	2P—200A	RNB38-8S
UP3000-HM10022	35mm ² /1AWG	2P—200A	RNB38-8S
UP5000-HM8042	35mm ² /1AWG	2P—200A	RNB38-8S

- **Making the battery connection wire**

Step1: Ring terminal 2pcs (included accessories).

Step2: Battery positive and negative connection wires 2 pcs(red +, black -). The wire length is determined according to the customer's actual requirement.

Step3: Strip one end of the battery connection wire for about d mm (size d is determined according to the ring terminal).

Step4: Pass the exposed wire through the ring terminal, and secure the wire firmly with a wire clamp.



2) AC Load

- **Recommended wire size of the AC load and the circuit breaker is as below.**

Model	Load wire size	Circuit breaker	Torque
UP2000-HM6021	6mm ² /9AWG	2P—40A	1.2N.M
UP2000-HM6022	3.4mm ² /12AWG	2P—16A	1.2N.M
UP3000-HM5041	6mm ² /9AWG	2P—40A	1.2N.M
UP3000-HM5042	4mm ² /11AWG	2P—25A	1.2N.M
UP3000-HM8041	6mm ² /9AWG	2P—40A	1.2N.M
UP3000-HM10021	6mm ² /9AWG	2P—40A	1.2N.M
UP3000-HM10022	4mm ² /11AWG	2P—25A	1.2N.M
UP5000-HM8042	6mm ² /9AWG	2P—40A	1.2N.M

- **Making the connection wire of the AC load:**

Strip the AC load connection wires (3 pcs) for about 10 mm.



Symbols	Abbreviation	Name	Color
L	LINE	Live wire	Brown/black
N	Neutral	Neutral line	Blue
	—	Ground line	Yellowish green

3) PV modules

- **Recommended wire size of the PV module and the circuit breaker is as below.**

Since the PV array's output current varies with the type, connection method, or sunlight angle, its minimum wire size can be calculated by the short circuit current(ISC). Please refer to the ISC value in the PV module's specifications. When the PV modules are connected in series, the total ISC equals any PV module's ISC. When the PV modules are connected in parallel, the total ISC equals all PV modules' ISC. Please refer to the table below:

Model	PV wire size	Circuit breaker
UP2000-HM6021	6mm ² /9AWG	2P—40A
UP2000-HM6022	4mm ² /11AWG	2P—25A
UP3000-HM5041	6mm ² /9AWG	2P—40A
UP3000-HM5042	6mm ² /9AWG	2P—40A
UP3000-HM8041	10mm ² /7AWG	2P—50A
UP3000-HM10021	6mm ² /9AWG	2P—40A
UP3000-HM10022	6mm ² /9AWG	2P—40A
UP5000-HM8042	6mm ² /9AWG	2P—40A

• **Making the connection wire of the PV module:**

Step1: Each MC4 male terminal and female terminal 1pcs(included accessories)

Step2: PV module positive and negative connection wires 2 pcs(red +, black -). The wire length is determined according to the customer's actual requirement.

Step3: Strip one end of the PV module positive wire for about 5mm, and press the exposed wire to the inner core of the MC4 male terminal, as shown below:



Step4: Tight press the copper wire and the MC4 male terminal's inner core with a plier and ensure the connection is secure.



Step5: Unscrew the nut of the MC4 male terminal, insert the inner core into the MC4 terminal, and screw the nut.



Step6: Strip one end of the PV module negative wire for about 5mm, and press the exposed wire to the inner core of the MC4 female head, as shown below:



Step7: Tight press the copper wire and the MC4 female head's inner core with a plier and ensure the connection is secure.



Step8: Unscrew the nut of the MC4 female terminal, insert the inner core into the MC4 terminal, and screw the nut.



4) Utility input

- Recommended wire size of the utility input and the circuit breaker is as below.

Model	Utility wire size	Circuit breaker	Torque
UP2000-HM6021	6mm ² /9AWG	2P—40A	1.2N.M
UP2000-HM6022	3.4mm ² /12AWG	2P—16A	1.2N.M
UP3000-HM5041	6mm ² /9AWG	2P—40A	1.2N.M
UP3000-HM5042	4mm ² /11AWG	2P—25A	1.2N.M
UP3000-HM8041	6mm ² /9AWG	2P—40A	1.2N.M
UP3000-HM10021	6mm ² /9AWG	2P—40A	1.2N.M
UP3000-HM10022	4mm ² /11AWG	2P—25A	1.2N.M
UP5000-HM8042	6mm ² /9AWG	2P—40A	1.2N.M

- Making the connection cable of the utility input:**

Strip two connection wires of the utility input for about 10 mm.



Symbols	Abbreviation	Name	Color
L	LINE	Live wire	Brown/black
N	Neutral	Neutral line	Blue

2.3 Determine the installation position

Step1: Remove mounting plate 1 and mounting plate 2 behind the inverter/charger with a screwdriver.

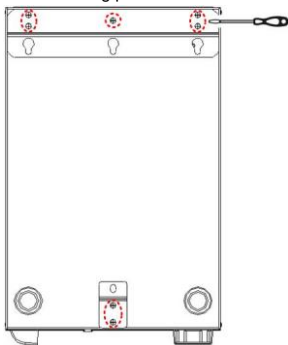

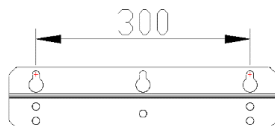

Step2: Mark the installation position with the mounting plate 1. The distance between the two mounting holes is 300mm.

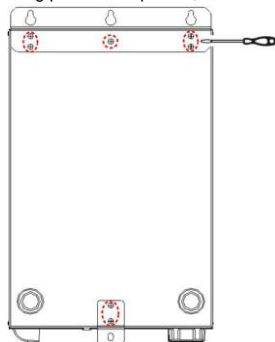

Step3: Rotate the direction of mounting plate 1 and plate 2, install them again.



2.4 Install the inverter/charger

 WARNING	<p>Risk of explosion! Never install the inverter/charger in a sealed enclosure with flooded batteries! Do not install the inverter/charger in a confined area where the battery gas can accumulate.</p>
 CAUTION	<ul style="list-style-type: none"> • The inverter/charger can be fixed to the concrete and solid brick walls and cannot be fixed to the hollow brick wall. • The inverter/charger requires at least 20cm of clearance right and left and 50cm of clearance above and below.

Step1: Determine the installation location and heat-dissipation space.

The inverter/charger requires at least 20cm of clearance right and left and 50cm of clearance above and below.

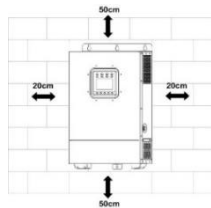

Step2: According to the installation position marked with the mounting plate 1, drill two M10 holes with an electric drill.

Step3: Insert the screws of the M8 bolts and the steel pipes into the two M10 holes.

Step4: Install the inverter/charger and determine the installation position of the M10 hole (located at the bottom of the inverter/charge).

Step5: Remove the inverter/charger and drill an M10 hole according to the position determined in **step4**.

Step6: Insert the screw of the M8 bolt and the steel pipe into the M10 hole.

Step7: Install the inverter/charger and secure the nuts with a sleeve.

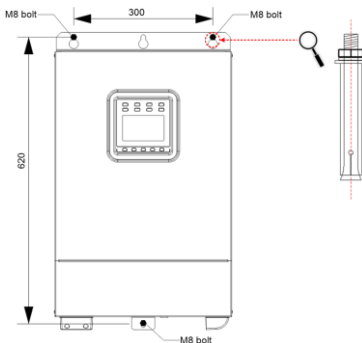

2.5 Wiring

1) Remove the terminal cover

Remove covers of the AC output /AC input/utility input terminal with a screwdriver, as shown below:

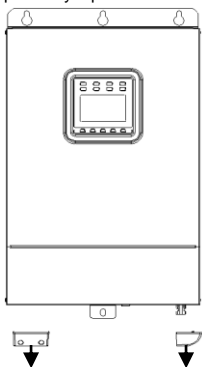

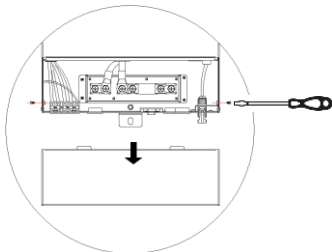

2) Remove the inverter/charger cover

Remove the screws beside the inverter/charger with a screwdriver, as shown below:



3) Connect the battery

 WARNING	<p>A circuit breaker must be installed on the battery side. For selection, please refer to chapter "2.2.2 Prepare modules".</p>
 CAUTION	<ul style="list-style-type: none"> • When wiring the battery, please do not close the circuit breaker and ensure that the leads of "+" and "-" poles are connected correctly. • A circuit breaker current is 1.25 to 2 times the rated current must be installed on the battery side away from the battery not longer than 200mm.

- **Connection sequence of the battery**

Step1: Remove the screw of the inverter/charger positive terminal with a sleeve, the torque of which is 3.5N.M.

Step2: Connect the ring terminal of the battery connection wire to the inverter/charger's positive terminal.

Step3: Install the screw and secure it with the sleeve.

Step4: Connect and secure the negative terminal of the inverter/charger following the step1-step3.

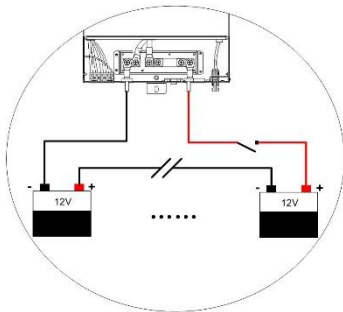

4) Connect the AC load

 WARNING	<ul style="list-style-type: none"> • Risk of electric shock! When wiring the AC load, please do not close the circuit breaker and ensure that the poles leads are connected correctly. • If utility input exists, the inverter/charger must be connected to the ground terminal.
---	--

- We do not assume any responsibility for the unnecessary danger when the ground terminal is not connected correctly.

Silk-screen	Abbreviation	Name	Color
L	LINE	Live wire	Brown/black
N	Neutral	Neutral line	Blue
	—	Ground line	Yellowish-green

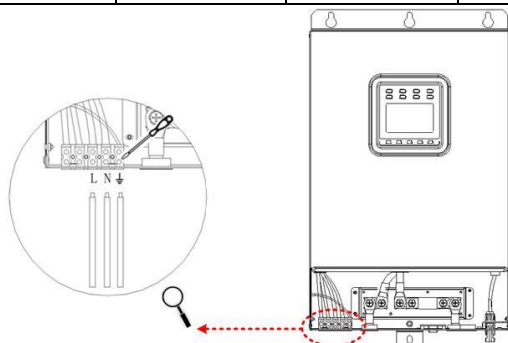

5) Connect the PV modules

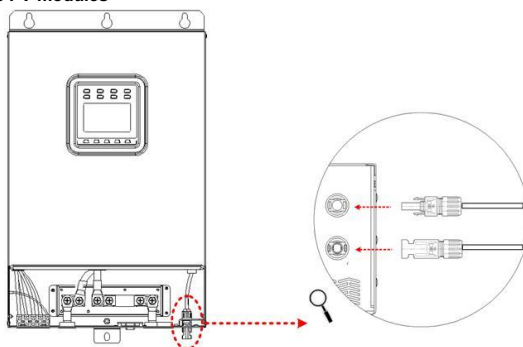

WARNING

Risk of electric shock! When wiring the PV modules, please do not close the circuit breaker and ensure that the leads of "+" and "-" poles are connected correctly.



CAUTION

If the inverter/charger is used in an area with frequent lightning strikes, installing an external surge arrester is recommended.

6) Connect the utility input



WARNING

Risk of electric shock! When wiring the utility input, please do not close the circuit breaker and ensure that the poles' leads are connected correctly.

Silk-screen	Abbreviation	Name	Color
L	LINE	Live wire	Brown/black
N	Neutral	Neutral line	Blue

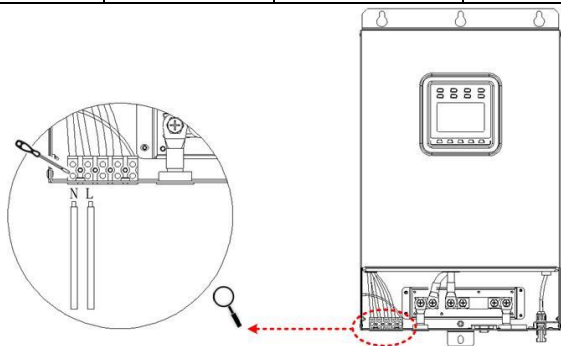

7) Connect accessories

A. RBVS interface

◇ Function:

This interface can be connected to the battery voltage sampling wire to detect the battery voltage accurately. The sampling distance is no longer than 20 meters.

◇ Needs:

3.81-2P terminal 1 pcs

Positive and negative(red+, black-) wire 1 pcs each (determine the length and wire size of the connecting wire according to the customer's actual needs.)

◇ Making the RBVS wire:

One end of the positive and negative wire is connected to the 3.81-2P terminal. The other end is connected to the positive and negative terminals of the battery.



CAUTION

When connecting the RBVS wire, ensure the positive and negative poles (red +, black -).

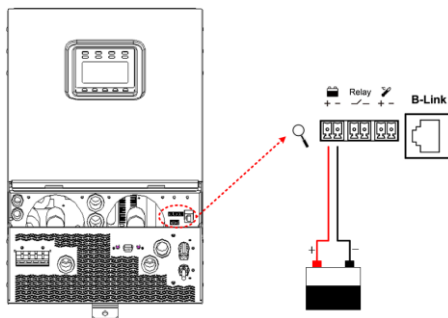

B. Dry contact interface

◇ Function:

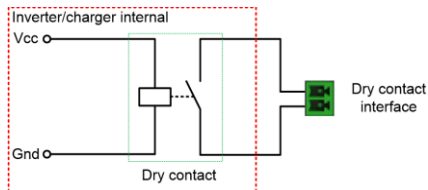

The dry contact interface can turn on/off the generator and is connected parallel with the generator's switch.



◇ Working principle:

When the battery voltage reaches the dry contact ON voltage(DON), the dry contact is connected. Its coil is energized. The dry contact can drive loads of no more than 125VAC /1A, 30VDC/1A. According to different battery types of the inverter charger, the default values of the dry contact ON(DON) voltage and the dry contact OFF(DOF) voltage are different. Please refer to the chapter [3.5 Settings](#) > item **19 DON** and item **20 DOF** for details.

C. Connect the RTS interface

Category	Name	Model	Picture
Included accessory	External temperature sensor	RT-MF58R47K3.81A	
Optional accessory	Remote Temperature Sensor	RTS300R47K3.81A	



Suppose the remote temperature sensor is not connected to the controller. The default setting for battery charging or discharging temperature is 25 °C without temperature compensation.

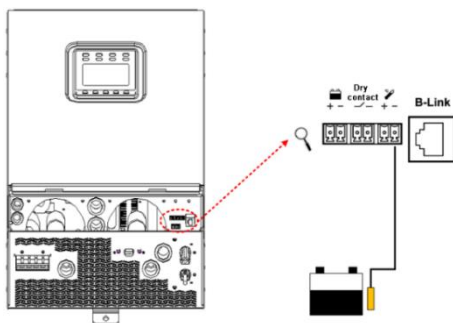

D. BMS-Link connection port (RJ45)

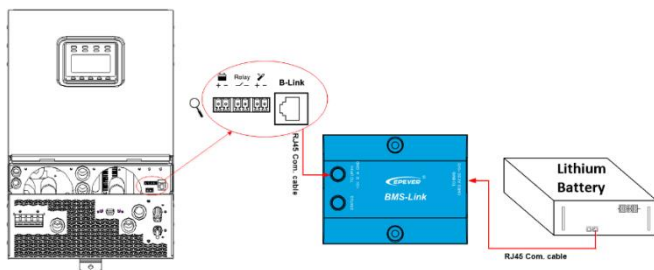

◇ Function:

Through a BMS-Link converter, different lithium battery manufacturers' BMS protocols can be converted into our company's standard BMS protocol. In addition, it realizes the communication between the inverter/charger and the BMS.

◇ Needs:

(Included)CC-RS485-RS485-350mm(Connect the inverter/charger to the BMS-Link converter)

(Optional)RS485 communication cable(Connect the lithium battery to the BMS-Link converter. Adjust the cable according to the lithium battery's BMS line sequence)



CAUTION

This connection port is only used to connect the BMS-Link converter. For details about the BMS-Link, please refer to *BMS-LINK Manual*.

E. RS485 interface (DB9 connector)

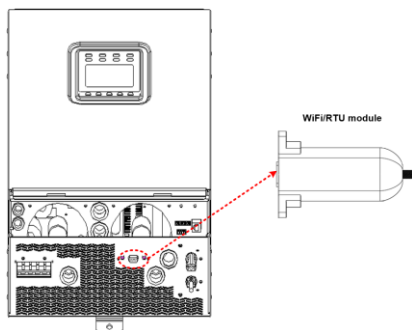

◇ **Function:**

For base UPower-Hi products, its DB9 interface provides 0.2A/5V power supply and can be connected to a WiFi module or PC.

For RTU-type UPower-Hi products, its DB9 interface provides 0.2A/12V power supply and can be connected to RTU, WiFi module, or PC.

8) Install the cover and secure the screws.

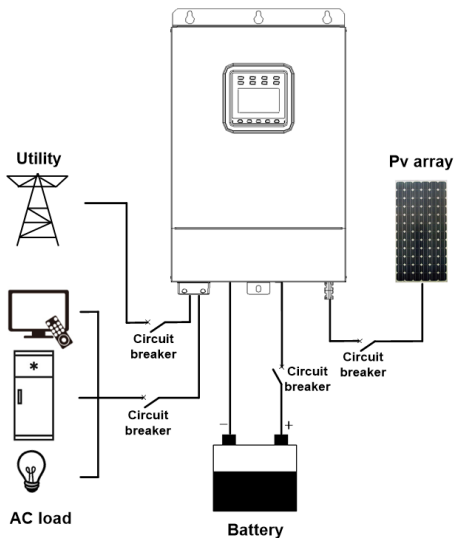

2.6 Operating the inverter/charger

- 1) Close the circuit breaker of the battery side.
- 2) Turn the rocker switch on the side of the inverter/charger to the ON state. The inverter/charger

generally works when the indicator is ON solid.







 WARNING	<p>Ensure that the battery connection is correct and the battery circuit breaker is turned on first. And then, close the PV array and utility circuit breakers after the inverter/charger running normally. Again, we won't assume any responsibility for not following the operation.</p>
---	--



- 3) Close the circuit breaker of the PV array.
- 4) Close the circuit breaker of the utility input.
- 5) After the AC output is normal, turn on the AC loads one by one. The inverter/charger typically works as per the set mode. Do not turn on all the loads simultaneously to avoid protection due to a large transient impulse current.

 CAUTION	<ul style="list-style-type: none"> • When supplying power for different AC loads, it is recommended to turn on the load with a large impulse current. And then turn on the load with a smaller impulse current after the load output is stable. • If the inverter/charger is not operating correctly or the LCD or the indicator shows an abnormality, please refer to "Troubleshooting" or contact us.
---	---





3 Interface

3.1 Indicator

Indicator	Color	Status	Definition
	Green	Off	No utility input
		On solid	Utility connected, but not charging
		Slowly flashing (0.5Hz)	Utility is charging
		Fast flashing (2.5Hz)	Utility charging fault
	Green	Off	No PV input
		On solid	PV connected, but not charging
		Slowly flashing (0.5Hz)	PV is charging
		Fast flashing (2.5Hz)	PV charging fault
	Green	Off	Inverter is off
		On solid	Inverter standby or bypass
		Slowly flashing (0.5Hz)	Inverter supplies power
		Fast flashing (2.5Hz)	Inverter fault
	Green	Off	Load off
		On solid	Load on
	Green	Off	Relay disconnected
		On solid	Relay connected
	Green	On solid	Remote control load on by cloud platform or phone APP

		Slowly flashing (0.5Hz)	Remote control load off by cloud platform or phone APP
		Off	No remote control
 Bypass	Green	Off	Inverter supplies power
		Slowly flashing (0.5Hz)	Utility supplies power
 Fault	Red	Off	Device normal
		On solid	Device fault

3.2 Button

Button	Operation	Instruction
	Click(<50ms)	Exit the current interface
	Long press(>2.5s)	Clear the faults
	Click(<50ms)	<ol style="list-style-type: none"> Browse/Setting Interface: "UP" for page up; "Down" for page down Modify parameter values: "UP" to increase the value; "DOWN" to decrease the value
	Click(<50ms)	<ol style="list-style-type: none"> Switch the page on the real-time monitoring interface Confirm settings
	Long press(>2.5s)	<ol style="list-style-type: none"> Switch between "Real-time monitoring interface," "Settings interface," "Parameters interface." Confirm settings
	Long press(>2.5s)	Switch on/off the AC output

3.3 LCD

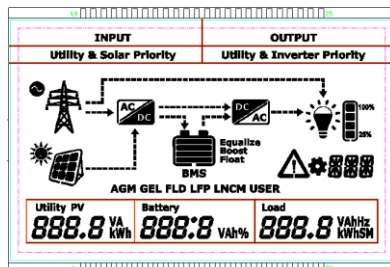

- Symbol definition

Symbol	Definition	Symbol	Definition
	Utility connected and charging		PV connected and charging
	1. Utility disconnected 2. Utility connected, but no charge		1. PV disconnected 2. PV connected, but the voltage is low
	Load ON		Load OFF
	Battery capacity [Ⓞ] lower than 15%		Battery capacity [Ⓞ] 15%~40%
	Battery capacity [Ⓞ] 40%~60%		Battery capacity [Ⓞ] 60%~80%
	Battery capacity [Ⓞ] 80%~100%	BMS	Symbol ON: Battery with BMS Symbol OFF: Battery without BMS Attention: Please follow the BMS control logic to set parameters when the battery with BMS.
	Load power 8~25%(one cell)		Load power 25~50%(two cells)
	Load power 50~75%(three cells)		Load power 75~100%(four cells)

① After the inverter/charger is powered on for the first time, the battery capacity displayed on the LCD may be inaccurate. To display the available battery capacity accurately, the below process of self-calibration and self-learning is necessary.



- When the battery voltage reaches the low voltage disconnect voltage or reaches the float charging voltage, the inverter/charger calibrates the battery capacity for the first time.
- When the battery goes from the over-discharged state to the fully-charged state, the inverter/charger calibrates the battery capacity again.



CAUTION

When the connected lithium battery (with BMS) is equipped with a battery capacity display, the lithium battery capacity will be displayed as per the BMS.

• **Interface Definition**

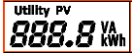
Item	Settings	Content
INPUT <hr/> Solar Priority	INPUT	Solar priority Utility & solar Solar
OUTPUT <hr/> Inverter Priority	OUTPUT	Utility priority Inverter priority
	Load	AC output voltage AC output current AC output power AC output frequency
	Battery	Battery voltage Max. charging current(PV charging current+ utility charging current) Battery temperature Battery SOC
	PV	PV input voltage PV input current PV input power PV input capacity
	Utility	Utility input voltage Utility charging input current Utility charging input power Utility input capacity
AGM GEL FLD LFP LNCM USER	Battery Type	AGM GEL FLD LFP8/LFP15/LFP16 LNCM7/LNCM14 AGM/GEL/FLD/LFP/LNCM+USER

3.4 Operating mode

1. Abbreviation

Abbreviation	Illustration
P_{PV}	PV power
P_{LOAD}	Load power
V_{BAT}	Battery voltage
LVR	Low voltage reconnect voltage
LVD	Low voltage disconnect voltage
AOF	Auxiliary module OFF voltage
AON	Auxiliary module ON voltage
MCC	Max charging current

2. Battery mode

INPUT	Solar	Only solar energy can charge the battery, no matter utility is available or not.
	Solar Priority	When PV power is sufficient, PV charges the battery. When the battery voltage is lower than AON, the utility charges the battery as a supplement; when the battery voltage is higher than AOF, the utility stops charging the battery. Note: AOF and AON setting refers to Item 17/18 on the Advanced interface for engineers.
	Utility & Solar	PV and utility charge the battery at the same time. When PV power is sufficient, the PV power is the primary source. Note: After selecting this working mode, the output mode is not controlled freely, though it can be set. Details refer to the below instructions.
OUTPUT	Inverter Priority	PV power is sufficient (namely, extra energy exists except charging the battery), PV supplies the load as a priority. When PV power is insufficient, the battery supplies the load as a supplement. When the battery voltage is lower than LVD, the utility supplies the load as a supplement. Note: LVD and LVR settings refer to Item 7 on the Standard interface for common users.
	Utility Priority	Utility supplies the load as a priority. When the utility is abnormal, the PV supplies the load as a supplement. When PV power is insufficient, the battery supplies

		the load as a supplement.
--	--	---------------------------

1) **Input source:** Solar (only solar energy charges the battery)

Output source: Inverter Priority

① **Both PV and utility are available**

When PV power is higher than load power, it charges the battery and supplies extra power to the load.

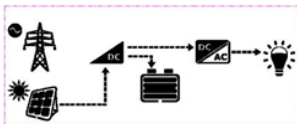

When PV power is lower than or equal to load power, PV stops charging the battery. Instead, it supplies the load together with the battery.

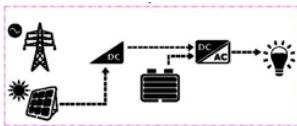

When the battery voltage goes lower than or equal to the LVD point, the utility supplies the load, and PV charges the battery.

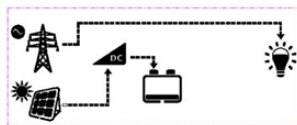

② **PV power is available, but the utility is not available**

When PV power is higher than load power, it charges the battery and supplies extra power to the load.

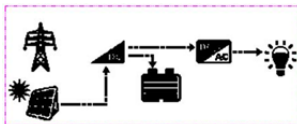

When PV power is lower than or equal to load power, PV stops charging the battery. Instead, it supplies the load together with the battery.

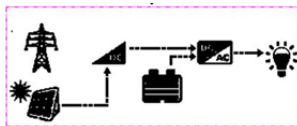

When the battery voltage goes lower than or equal to the LVD point, only PV charges the battery.

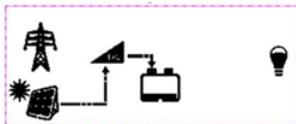

③ PV power is not available, and the utility is available.

The battery supplies the load alone.

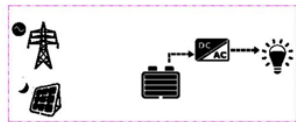

When the battery voltage goes lower than or equal to the LVD point, the utility supplies load.



④ Both PV power and utility are not available.

Before the battery voltage drops to the LVD point, the battery supplies the load.

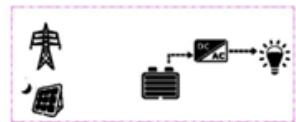

2) Input source: Solar (only solar energy charges the battery)

Output source: Utility Priority

① Both PV and utility are available

Utility supplies the load, and PV charges the battery.

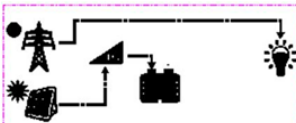

② PV power is available, but the utility is not available

When PV power is higher than load power, it charges the battery and supplies extra power to the load.

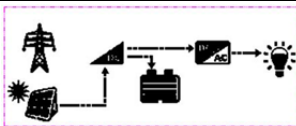

When PV power is lower than or equal to load power, PV stops charging the battery. Instead, it supplies the load together with the battery.

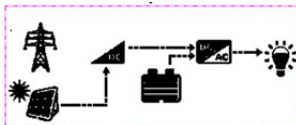

When the battery voltage goes lower than or equal to the LVD point, only PV charges the battery.

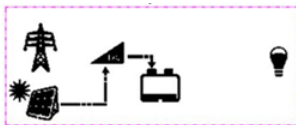

③ PV power is not available, and the utility is available.

Utility supplies the load.



④ Both PV power and utility are not available.

Before the battery voltage drops to the LVD point, the battery supplies the load.

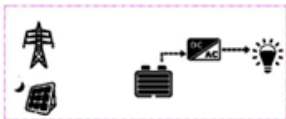

3) Input source: **Solar Priority**

Output source: **Inverter Priority**

① Both PV and utility are available

When PV power is higher than load power, it charges the battery and supplies extra power to the load.

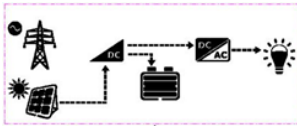

When PV power is lower than or equal to load power, PV stops charging the battery. Instead, it supplies the load together with the battery.

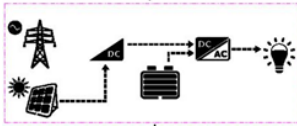

When the battery voltage goes lower than or equal to AON and has not been charged to AOF, the below interfaces show different conditions.

- When PV power is lower than or equal to $MCC \cdot V_{BAT}$, the utility supplies the load alone and charges the battery together with the PV.

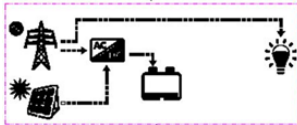

- When PV power is higher than $MCC \cdot V_{BAT}$, PV charges the battery alone and supplies the load together with the utility.

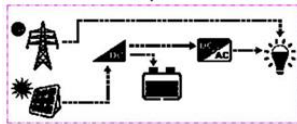

② PV power is available, but the utility is not available

When PV power is higher than load power, it charges the battery and supplies extra power to the load.

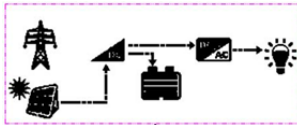

When PV power is lower than or equal to load power, PV stops charging the battery. Instead, it supplies the load together with the battery.

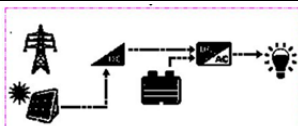

When the battery voltage goes lower than or equal to the LVD point, only PV charges the battery.

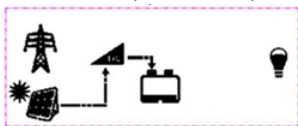

③ PV power is not available, and the utility is available.

The battery supplies the load alone.

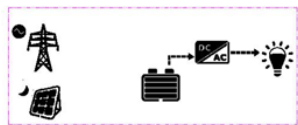

The battery voltage goes lower than or equal to AON. Simultaneously, it has not been charged to AOF. Instead, the utility supplies the load and charges the battery.

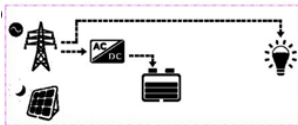

④ Both PV power and utility are not available.

Before the battery voltage drops to the LVD point, the battery supplies the load.

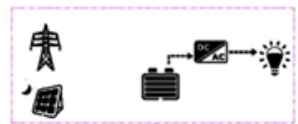

4) Input source: Solar Priority

Output source: Utility Priority

① Both PV and utility are available

PV charges the battery, and the utility supplies the load.

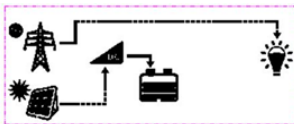

When the battery voltage goes lower than or equal to AON and has not been charged to AOF, the below interfaces show different conditions.

- When PV power is lower than or equal to $MCC \cdot V_{BAT}$, the utility supplies the load alone and charges the battery together with the PV.

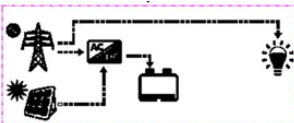

- When PV power is higher than $MCC \cdot V_{BAT}$, the PV charges the battery alone and supplies the load together with the utility.

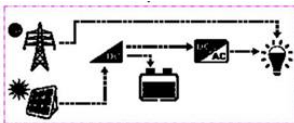

② PV power is available, but the utility is not available

When PV power is higher than load power, it charges the battery and supplies extra power to the load.

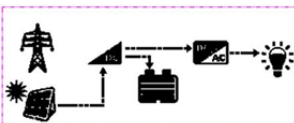

When PV power is lower than or equal to load power, PV stops charging the battery. Instead, it supplies the load together with the battery.

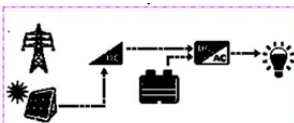

When the battery voltage goes lower than or equal to the LVD point, only PV charges the battery.

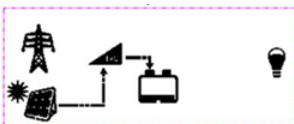

③ PV power is not available, and the utility is available.

The utility supplies the load alone.



The battery voltage goes lower than or equal to AON. Simultaneously, it has not been charged to AOF. Instead, the utility supplies the load and charges the battery.

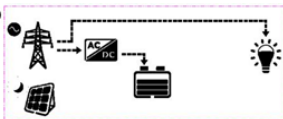

④ Both PV power and utility are not available.

Before the battery voltage drops to the LVD point, the battery supplies the load.

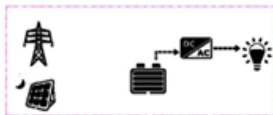

5) Input source: **Solar and PV charge the battery**

Output source: Unprogrammable

① Both PV and utility are available

When PV power is lower than or equal to $MCC \cdot V_{BAT}$, the utility supplies the load alone and charges the battery together with the PV.

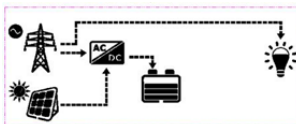

When PV power is higher than $MCC \cdot V_{BAT}$, the PV charges the battery alone and supplies the load together with the utility.

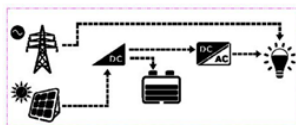

② PV power is available, but the utility is not available

When PV power is higher than load power, it charges the battery and supplies extra power to the

load.

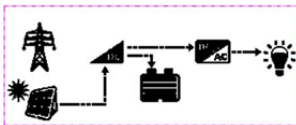

When PV power is lower than or equal to load power, PV stops charging the battery. Instead, it supplies the load together with the battery.

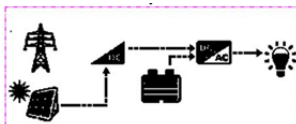

When the battery voltage goes lower than or equal to the LVD point, only PV charges the battery.

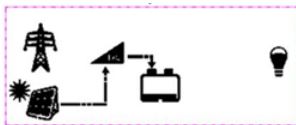

③ PV power is not available, and the utility is available.

Utility supplies the load and charges the battery.

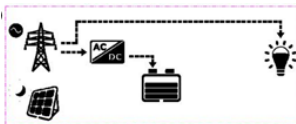

④ Both PV power and utility are not available.

Before the battery voltage drops to the LVD point, the battery supplies the load.

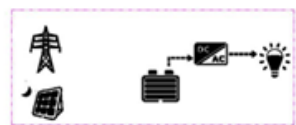

3. No battery mode

PV supplies the load when the PV input voltage is 80V for UP3000-HM5042 and 120V for UP5000-HM8042.

① Both PV and utility are available

PV supplies the load together with the utility.

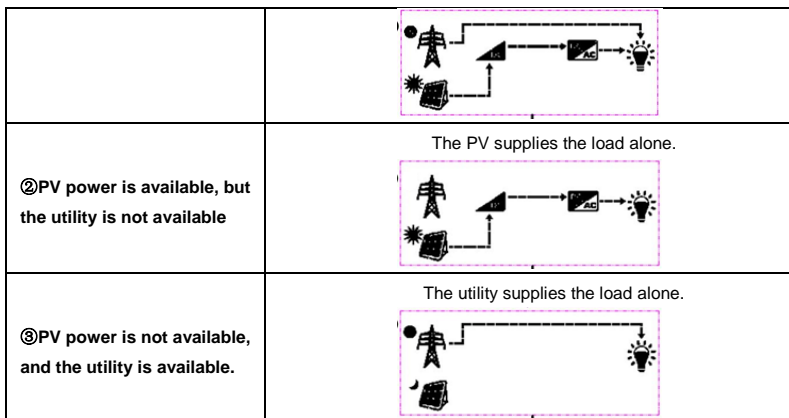

4. The PV open-circuit voltage V_s Max. PV input power curve as below:

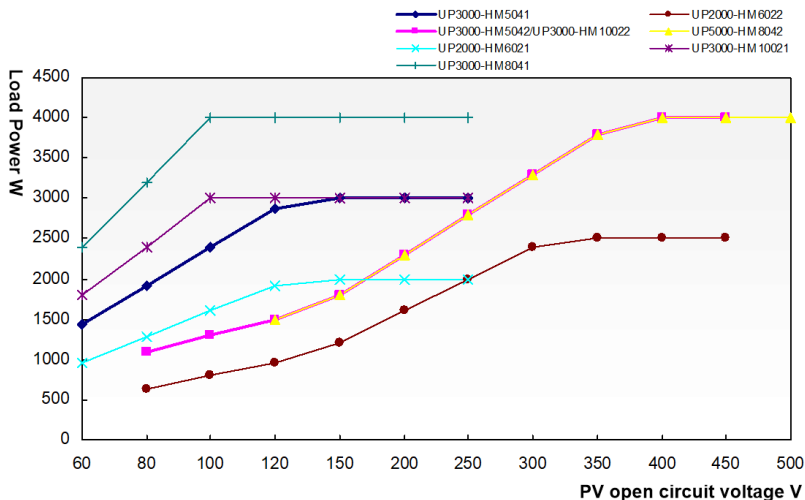

Model	Min. PV working voltage	Max. PV open-circuit voltage	Max. PV input power
UP2000-HM6021	60V	250V(At minimum temperature) 220V(25°C)	2000W
UP2000-HM6022	80V	450V(At minimum temperature) 395V(25°C)	2500W
UP3000-HM5041	60V	250V(At minimum temperature) 220V(25°C)	3000W

UP3000-HM5042	80V	450V(At minimum temperature) 395V(25°C)	4000W
UP3000-HM8041	60V	250V(At minimum temperature) 220V(25°C)	4000W
UP3000-HM10021	60V	250V(At minimum temperature) 220V(25°C)	3000W
UP3000-HM10022	80V	450V(At minimum temperature) 395V(25°C)	4000W
UP5000-HM8042	120V	500V(At minimum temperature) 440V(25°C)	4000W

3.5 Settings

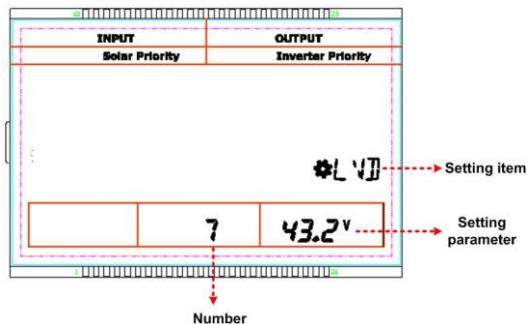

1) Standard interface for common users

Operations:

- Step1:** In the real-time interface, long press the SET/ENTER button to enter the standard interface.
- Step2:** Press the UP/DOWN button to select the setting item.
- Step3:** Long press the SET/ENTER button to enter the parameter setting interface.
- Step4:** Press the UP/DOWN button to change the parameters.
- Step5:** Press the SET/ENTER button to confirm.
- Step6:** Press the ESC button to exit.

Setting items:

NO.	Instruction	Setting	
0	No battery mode or battery mode	BTS 0 YES	Battery mode(Default)
		BTS 0 NO	No battery mode

1	Battery type	AGM 1 *ETP	AGM(Default)
		GEL 1 *ETP	GEL
		FLD 1 *ETP	FLD
		LFP 1 8 *ETP	LFP8
		LFP 1 15 *ETP	LFP15
		LFP 1 16 *ETP	LFP16
		LNCM 1 7 *ETP	LNCM7
		LNCM 1 14 *ETP	LNCM14
		AGM USER 1 *ETP	AGM/GEL/FLD/LFP/LNCM+USER Important: USER battery type can be combined with other battery types and set corresponding parameters.
		2	Charging mode
INPUT Utility & Solar 2 *CSP	Utility & solar		
INPUT Solar 2 *CSP	Solar		
3	Output mode	OUTPUT Utility Priority 3 *OSP	Utility priority(Default)

		<p style="text-align: center;">OUTPUT Inverter Priority</p> <p style="text-align: center;">*OSP</p> <p style="text-align: center;">3</p>	Inverter priority
4	Temperature unit	<p style="text-align: center;">*TMU</p> <p style="text-align: center;">4 C</p>	°C(Default)
		<p style="text-align: center;">*TMU</p> <p style="text-align: center;">4 F</p>	°F
5	LCD backlight time	<p style="text-align: center;">*BLT</p> <p style="text-align: center;">5 30.0 s</p>	30S(Default)
		<p style="text-align: center;">*BLT</p> <p style="text-align: center;">5 60.0 s</p>	60S
		<p style="text-align: center;">*BLT</p> <p style="text-align: center;">5 100.0 s</p>	100S(on solid)
6	Buzzer alarm switch	<p style="text-align: center;">*BAS</p> <p style="text-align: center;">6 ON</p>	ON(Default)
		<p style="text-align: center;">*BAS</p> <p style="text-align: center;">6 OFF</p>	OFF
7	Low voltage disconnect voltage	<p style="text-align: center;">AGM *LV1</p> <p style="text-align: center;">7 21.5V</p> <p>AGM(Default)/GEL/FLD: 21.6V LFP8: 25.5V LCNM7: 25.5V</p>	User define for the 24V system: 21.6~32.0V Step size: long press for 1V, short press for 0.1V
		<p style="text-align: center;">AGM *LV2</p> <p style="text-align: center;">7 43.2V</p> <p>AGM(Default)/GEL/FLD: 43.2V LFP15: 47.8V LFP16: 51.0V LCNM14: 51.0V</p>	User define for the 48V system: 43.2~64.0V Step size: long press for 1V, short press for 0.1V
8	Low voltage reconnect voltage	<p style="text-align: center;">AGM *LR</p> <p style="text-align: center;">8 25.0V</p> <p>AGM(Default)/GEL/FLD: 25.0V LFP8: 26.0V LCNM7: 26.0V</p>	User define for the 24V system: 21.6~32.0V Step size: long press for 1V, short press for 0.1V
		<p style="text-align: center;">AGM *LR</p> <p style="text-align: center;">8 50.0V</p>	User define for the 48V system: 43.2~64.0V

		AGM(Default)/GEL/FLD: 50.0V LFP15: 48.8V LFP16: 52.0V LCNM14: 52.0V	Step size: long press for 1V, short press for 0.1V
--	--	--	---



CAUTION

When the output mode is inverter priority, and the battery voltage is lower than the low voltage disconnect voltage (configurable), the utility supplies the load.

2) **Advanced interface for engineers**

Operations:

Step1: In the real-time interface, long press the UP+DOWN button to enter the advanced interface.

Step2: Press the UP/DOWN button to select the setting item.

Step3: Long press the SET/ENTER button to enter the parameter configuring the interface.

Step4: Press the UP/DOWN button to modify the parameters.

Step5: Press the SET/ENTER button to confirm.







Step6: Press the ESC button to exit.

Setting items:

NO.	Instruction	Setting	
9	Boost charging time	AGM	*ECT 9 30 H 30M
		AGM	*ECT 9 60 H 60M
		AGM	*ECT 9 120 H 120M(Default)
		AGM	*ECT 9 180 H 180M
10	Equalize charging time	AGM	*ECT 10 30 H 30M
		AGM	*ECT 10 60 H 60M
		AGM	*ECT 10 120 H 120M(Default)
		AGM	*ECT 10 180 H 180M
11	Equalize charging voltage	AGM	*ECT 11 29.2V It cannot be set, which changes depending on the boost charging voltage.
		AGM(Default): 29.2V GEL: —	







		FLD: 29.6V LFP8: 28.2V LCNM7: 28.9V *E C V AGM 11 58.4V	
		AGM(Default): 58.4V GEL: -- FLD: 59.2V LFP15: 53.0V LFP16: 56.5V LCNM14: 57.8V *E C V AGM 12 28.8V	
12	Boost charging voltage	AGM(Default): 28.8V GEL: 28.4V FLD: 29.2V LFP8: 28.2V LCNM7: 28.9V *E C V AGM 12 57.6V	User define for the 24V system: 21.6~32.0V Step size: long press for 1V, short press for 0.1V
		AGM(Default): 57.6V GEL: 56.8V FLD: 58.4V LFP15: 53.0V LFP16: 56.5V LCNM14: 57.8V *E C V AGM 13 26.4V	User define for the 48V system: 43.2~64.0V Step size: long press for 1V, short press for 0.1V
13	Boost voltage reconnect voltage	AGM(Default)/GEL/FLD: 26.4V LFP8: 26.4V LCNM7: 26.8V *E C V AGM 13 52.8V	User define for the 24V system: 21.6~32.0V Step size: long press for 1V, short press for 0.1V
		AGM(Default)/GEL/FLD: 52.8V LFP15: 49.5V LFP16: 52.8V LCNM14: 53.6V *E C V AGM 14 27.6V	User define for the 48V system: 43.2~64.0V Step size: long press for 1V, short press for 0.1V
14	Float charging	*E C V AGM 14 27.6V	User define for the 24V system: 21.6~32.0V Step size: long press for 1V, short press for 0.1V







	voltage	AGM(Default)/GEL/FLD: 27.6V LFP8: 27.2V LCNM7: 28.2V	
		AGM *0.4V 14 55.2V	
		AGM(Default)/GEL/FLD: 55.2V LFP15: 51.0V LFP16: 54.4V LCNM14: 56.4V	
15	Over voltage reconnect voltage	AGM *0.4V 15 30.0V	User define for the 24V system: 21.6~32.0V Step size: long press for 1V, short press for 0.1V
		AGM(Default)/GEL/FLD: 30.0V LFP8: 28.5V LCNM7: 29.0V	
		AGM *0.4V 15 60.0V	User define for the 48V system: 43.2~64.0V Step size: long press for 1V, short press for 0.1V
		AGM(Default)/GEL/FLD: 60.0V LFP15: 53.5V LFP16: 57.0V LCNM14: 58.0V	
16	Over voltage disconnect voltage	AGM *0.4V 16 32.0V	User define for the 24V system: 21.6~32.0V Step size: long press for 1V, short press for 0.1V
		AGM(Default)/GEL/FLD: 32.0V LFP8: 29.0V LCNM7: 30.0V	
		AGM *0.4V 16 64.0V	User define for the 48V system: 43.2~64.0V Step size: long press for 1V, short press for 0.1V
		AGM(Default)/GEL/FLD: 64.0V LFP15: 54.5V LFP16: 58.0V LCNM14: 60.0V	
17	Auxiliary module OFF voltage	AGM *0.4V 17 28.0V	User define for the 24V system: 21.6~32.0V Step size: long press for 1V, short press for 0.1V NOTE: The difference between AOF and AON should be larger than or equal to 0.5V, or else the setting cannot be saved.
		AGM(Default)/GEL/FLD: 28.0V LFP8: 26.6V LCNM7: 27.0V	
		AGM *0.4V 17 56.0V	User define for the 48V system: 43.2~64.0V Step size: long press for 1V, short press for 0.1V

		AGM(Default)/GEL/FLD: 56.0V LFP15: 50.0V LFP16: 53.3V LCNM14: 54.0V	NOTE: The difference between AOF and AON should be larger than or equal to 1V, or else the setting cannot be saved.
18	Auxiliary module ON voltage	AGM  18 24.0 ^v	User define for the 24V system: 21.6~32.0V Step size: long press for 1V, short press for 0.1V
		AGM(Default)/GEL/FLD: 24.0V LFP8: 24.0V LCNM7: 24.5V	NOTE: The difference between AOF and AON should be larger than or equal to 0.5V, or else the setting cannot be saved.
		AGM  18 48.0 ^v	User define for the 48V system: 43.2~64.0V Step size: long press for 1V, short press for 0.1V
		AGM(Default)/GEL/FLD: 48.0V LFP15: 45.0V LFP16: 48.0V LCNM14: 49.0V	NOTE: The difference between AOF and AON should be larger than or equal to 1V, or else the setting cannot be saved.
19	Dry contact ON voltage	AGM  19 22.2 ^v	User define for the 24V system: 21.6~32.0V Step size: long press for 1V, short press for 0.1V
		AGM(Default)/GEL/FLD: 22.2V LFP8: 22.2V LCNM7: 21.7V	
		AGM  19 44.4 ^v	User define for the 48V system: 43.2~64.0V Step size: long press for 1V, short press for 0.1V
		AGM(Default)/GEL/FLD: 44.4V LFP15: 41.6V LFP16: 44.4V LCNM14: 43.4V	
20	Dry contact OFF voltage	AGM  20 24.0 ^v	User define for the 24V system: 21.6~32.0V Step size: long press for 1V, short press for 0.1V
		AGM(Default)/GEL/FLD: 24.0V LFP8: 24.0V LCNM7: 24.5V	
		AGM  20 48.0 ^v	User define for the 48V system: 43.2~64.0V Step size: long press for 1V, short press for 0.1V
		AGM(Default)/GEL/FLD: 48.0V LFP15: 45.0V LFP16: 48.0V LCNM14: 49.0V	
21	Maximum charging	AGM  21 80.0 ^A	UP3000-HM5041/UP3000-HM5042: 50A(Default) User define: 5~50A

	current		<p>UP2000-HM6021/UP2000-HM6022: 60A(Default) User define: 5~60A</p> <p>UP3000-HM10021/UP3000-HM10022: 100A(Default) User define: 5~100A</p> <p>UP3000-HM8041/UP5000-HM8042: 80A (默认) User define: 5~80A</p> <p>Step size: long press for 50A, short press for 5A</p>
22	Max. utility charging current	<p>AGH</p> <p>22 50.0 ^A</p> <p>*MUC</p>	<p>UP2000-HM6021/UP2000-HM6022/UP5000-HM8042: 60A(Default) User define: 2~60A</p> <p>UP3000-HM5041/UP3000-HM5042/UP3000-HM8041: 40A(Default) User define: 2~40A</p> <p>UP3000-HM10021/UP3000-HM10022: 80A(Default) User define: 2~80A</p> <p>Step size: long press for 10A, short press for 1A</p>
24	Clear fault	<p>AGH</p> <p>24 OFF</p> <p>*EFA</p>	OFF(Default)
		<p>AGH</p> <p>24 ON</p> <p>*EFA</p>	ON
25	Clear the PV accumulated energy	<p>AGH</p> <p>25 OFF</p> <p>*ECL</p>	OFF(Default)
		<p>AGH</p> <p>25 ON</p> <p>*ECL</p>	ON
26	Battery capacity	<p>AGH</p> <p>26 1000 ^{Ah}</p> <p>*TEC</p>	<p>100AH(Default) User define:1~4000AH Step size: Below 200AH: long press for 10A, short press for 1A Above 200AH: long press for 50A, short press for 5A CAUTION: To accurately display the battery capacity, the customer needs to set this item according to the actual battery capacity.</p>
27	Temperature compensation coefficient	<p>AGH</p> <p>27 3</p> <p>*TEC</p>	<p>3(Default) 0(lithium battery) 0~9(Non-lithium battery) Step size is 1</p>
28	Low temperature	<p>AGH</p> <p>28 0 ^C</p> <p>*TLC</p>	<p>0°C(Default) User define:-40~0°C Step size: 5°C</p>

	prohibits charge temperature		
29	Low temperature prohibits discharge temperature	*TLL AGM 29 0C	0°C(Default) User define:-40~0°C Step size: 5°C
30	Output voltage level	*VPT AGM 30 110.0V	110VAC(Default for devices of 100V output voltage)
		*VPT AGM 30 120.0V	120VAC
		*VPT AGM 30 220.0V	220VAC(Default for devices of 200V output voltage)
		*VPT AGM 30 230.0V	230VAC
31	Output frequency (If detecting the utility input, the output frequency is switched to the utility frequency automatically.)	*FRE AGM 31 50.0 Hz	50Hz(Default)
		*FRE AGM 31 60.0 Hz	60Hz
32	Lithium battery protection enable(stop charging and	*LEN AGM 32 OFF	OFF(Default)
		*LEN AGM 32 ON	ON (Note: After connecting to the BMS successfully, it will be ON status automatically.)

	discharging the lithium battery when the temperature is too low)		
33	Charging limit voltage	 33 30.0^v	User define for the 24V system: 21.6~32.0V Step size: long press for 1V, short press for 0.1V
		AGM(Default)/GEL/FLD: 30.0V LFP8: 28.5V LCNM7: 29.4V	
		 33 60.0^v	User define for the 48V system: 43.2~64.0V Step size: long press for 1V, short press for 0.1V
		AGM(Default)/GEL/FLD: 60.0V LFP15: 53.5V LFP16: 57.0V LCNM14: 58.8V	
35	Under voltage warning reconnect voltage	 35 24.4^v	User define for the 24V system: 21.6~32.0V Step size: long press for 1V, short press for 0.1V
		AGM(Default)/GEL/FLD: 24.4V LFP8: 26.2V LCNM7: 26.7V	
		 35 48.8^v	User define for the 48V system: 43.2~64.0V Step size: long press for 1V, short press for 0.1V
		AGM(Default)/GEL/FLD: 48.8V LFP15: 49.2V LFP16: 52.4V LCNM14: 53.4V	
36	Under voltage warning voltage	 36 24.0^v	User define for the 24V system: 21.6~32.0V Step size: long press for 1V, short press for 0.1V
		AGM(Default)/GEL/FLD: 24.0V LFP8: 25.7V LCNM7: 26.2V	
		 36 48.0^v	User define for the 48V system: 43.2~64.0V Step size: long press for 1V, short press for 0.1V
		AGM(Default)/GEL/FLD: 48.0V LFP15: 48.2V	

		LFP16: 51.4V LCNM14: 52.4V	
37	Utility over voltage disconnection voltage	AGM  U _{OV} 37 132.0V	132.0V (Default for the 110V system) User define: 110VAC~140VAC Step size: long press for 10V, short press for 1V
		AGM  U _{OV} 37 264.0V	264.0V (Default for the 220V system) User define: 220VAC~290VAC Step size: long press for 10V, short press for 1V
38	Utility low voltage disconnection voltage	AGM  U _{LI} 38 88.0V	88.0V (Default for the 110V system) User define: 80VAC~110VAC Step size: long press for 10V, short press for 1V
		AGM  U _{LI} 38 176.0V	176.0V (Default for the 220V system) User define: 90VAC~190VAC Step size: long press for 10V, short press for 1V
39	Battery discharge current limit Refer to 3.7 for details.	AGM  I _{DC} 39 250.0A	UP2000-HM6021/JP2000-HM6022: 200A(Default) User define: 10~200A UP3000-HM5041/JP3000-HM5042/UP3000-HM8041: 150A(Default) User define: 10~150A UP3000-HM10021/UP3000-HM10022: 300A(Default) User define: 10~300A UP5000-HM8042: 250A(Default) User define: 10~250A Step size: Long press for 10A, short press for 1A
40	lithium battery protocol type	AGM  PRO 40 1	1(Default) User Define: 1~10 NOTE: Refer to the (3) Lithium battery BMS Interface of chap 1
41	Software version	AGM  VER 41 U-1.0	U-1.0(Default) It cannot be modified. NOTE: Detail version refers to the actual display.

3.6 Battery voltage customized logic.

For the above items 7-16 and 33-36, please follow the below rules strictly.

1) In the 24V input voltage system, the following rules must be followed when modifying the parameter values in the user battery type for a Lead-acid battery.

- Over Voltage Disconnect Voltage \geq Over Voltage Reconnect Voltage + 0.5V
- Over Voltage Disconnect Voltage > Charging Limit Voltage \geq Equalize Charging Voltage \geq Boost Charging Voltage \geq Float Charging Voltage > Boost Reconnect Charging Voltage
- Low Voltage Reconnect Voltage \geq Low Voltage Disconnect Voltage + 0.5V

D. Low Voltage Reconnect Voltage > Low Voltage Disconnect Voltage \geq Discharging Limit Voltage(21.2V)

E. Under Voltage Warning Reconnect Voltage-0.5V \geq Under Voltage Warning Voltage \geq Discharging Limit Voltage(21.2V)

F. Boost Reconnect Charging voltage > Low Voltage Disconnect Voltage

2) In the 48V input voltage system, the following rules must be followed when modifying the parameter values in the user battery type for a Lead-acid battery.

A. Over Voltage Disconnect Voltage \geq Over Voltage Reconnect Voltage+1V

B. Over Voltage Disconnect Voltage > Charging Limit Voltage \geq Equalize Charging Voltage \geq Boost Charging Voltage \geq Float Charging Voltage > Boost Reconnect Charging Voltage

C. Low Voltage Reconnect Voltage \geq Low Voltage Disconnect Voltage+1V

D. Low Voltage Reconnect Voltage > Low Voltage Disconnect Voltage \geq Discharging Limit Voltage(42.4V)

E. Under Voltage Warning Reconnect Voltage-1V \geq Under Voltage Warning Voltage \geq Discharging Limit Voltage(42.4V)

F. Boost Reconnect Charging voltage > Low Voltage Disconnect Voltage

3) In the 24V input voltage system, the following rules must be followed when modifying the parameter values in the user battery type for a lithium battery.

A. Over Voltage Disconnect Voltage \geq Over Voltage Reconnect Voltage+0.5V

B. Over Voltage Disconnect Voltage>Over Voltage Reconnect Voltage=Charging Limit Voltage \geq Equalize Charging Voltage=Boost Charging Voltage \geq Float Charging Voltage>Boost Reconnect Charging Voltage

C. Low Voltage Reconnect Voltage \geq Low Voltage Disconnect Voltage+0.5V

D. Low Voltage Reconnect Voltage>Low Voltage Disconnect Voltage \geq Discharging Limit Voltage(21.2V)

E. Under Voltage Warning Reconnect Voltage-0.5V \geq Under Voltage Warning Voltage \geq Discharging Limit Voltage(21.2V)

F. Boost Reconnect Charging Voltage> Low Voltage Reconnect Voltage

4) In the 48V input voltage system, the following rules must be followed when modifying the parameter values in the user battery type for a lithium battery.

A. Over Voltage Disconnect Voltage \geq Over Voltage Reconnect Voltage+1V

B. Over Voltage Disconnect Voltage>Over Voltage Reconnect Voltage=Charging Limit Voltage \geq Equalize Charging Voltage=Boost Charging Voltage \geq Float Charging Voltage>Boost Reconnect Charging Voltage

C. Low Voltage Reconnect Voltage \geq Low Voltage Disconnect Voltage+1V

- D. Low Voltage Reconnect Voltage > Low Voltage Disconnect Voltage \geq Discharging Limit Voltage(42.4V)
- E. Under Voltage Warning Reconnect Voltage-1V \geq Under Voltage Warning Voltage \geq Discharging Limit Voltage(42.4V)
- F. Boost Reconnect Charging Voltage > Low Voltage Reconnect Voltage

 WARNING	The lithium battery's voltage parameters must be set according to the voltage parameters of BMS.
---	--

3.7 Battery discharge current limit

The function is suitable for the current limiting requirements of lithium batteries.

Abbreviation:

V_{BAT}	Battery voltage
V_{OUT}	Inverter output voltage
I_{BAT}	Actual battery current
UMI	Utility low voltage disconnection voltage
BDC	Battery discharge current limit value(Setting value)
BDC-MAX	Max. Battery discharge current limit value

V—I curve:

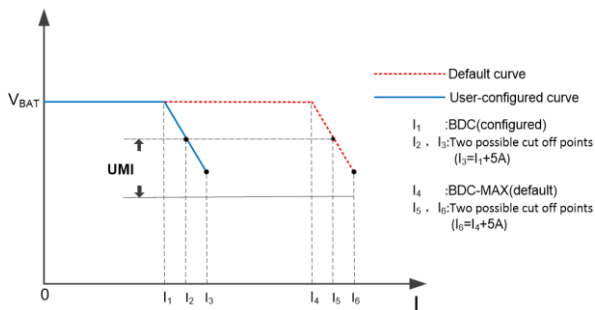

4 Protections

No.	Protection	Instruction		
1	PV limit current	<p>When the charging current of the PV array exceeds its rated current, it will be charged at the rated current.</p> <p>NOTE: When the charging current exceeds the PV array's rated current, ensure the PV open-circuit voltage no exceed the "maximum PV open-circuit voltage." Otherwise, the inverter/charger may be damaged.</p>		
2	PV reverse polarity	Fully protect against PV reverse polarity, correct the wire connection to resume the regular operation.		
3	Night reverse charging	Prevent the battery from discharging through the PV module at night.		
4	Utility input over voltage	<p>In the 110V/120VAC system, when the utility voltage exceeds 132V, it will stop utility charging/discharging.</p> <p>In the 220V/230VAC system, when the utility voltage exceeds 264V, it will stop utility charging/discharging.</p>		
5	Utility input under voltage	<p>In the 110V/120VAC system, when the utility voltage is less than 88V, it will stop utility charging/discharging.</p> <p>In the 220V/230VAC system, when the utility voltage is less than 176V, it will stop utility charging/discharging.</p>		
6	Utility input over current	Utility input current higher than a specified value, the device will go into protection mode automatically. Press the over-current protection device to resume working when the utility input current decreases to the expected value.		
7	Battery reverse polarity	When the PV array and utility are not connected with the inverter/charger, reverse battery polarity will not damage the inverter/charger. It will resume normal running after the mis-wiring is corrected.		
8	Battery over voltage	When the battery voltage reaches the Over Voltage Disconnect Voltage point, the inverter/charger will stop charging the battery to prevent battery damage due to over charged.		
9	Battery over discharge	When the battery voltage reaches the Low Voltage Disconnect Voltage point, the inverter/charger will automatically stop discharging the battery to prevent battery damage due to over discharge.		
10	Load output short circuit	When a short circuit occurs at the load output terminal, the output will be turned off immediately. The output will then be automatically restored after a delay (the first time delay for 5s, the second time delay for 10s, the third time delay for 15s). If the short circuit remains after three times delay, clear the fault and then restart the inverter/charger to resume work.		
11	Overload	Times of overload	1.3	1.5

		Continuance	10S	5S
		Recover three times	The first time delay for 5s, the second time delay for 10s, the third time delay for 15s	
12	Inverter/charger overheating	The inverter/charger will stop charging/discharging when the internal temperature is too high and will resume charging/discharging when the temperature is recovered to normal.		

5 Troubleshooting

5.1 Error codes

Code	Fault	battery frame blink	Indicator	Buzzer	Fault Indicator
BLV	Battery low voltage	Flashing	--	--	--
BOV	Battery over voltage	Flashing	--	--	--
BOB	Battery over discharge	Flashing	--	--	--
COV	Cell over voltage	Flashing	--	--	--
CLV	Cell low voltage	Flashing	--	--	--
CLT	Cell low temperature	Flashing	--	--	--
COT	Cell over temperature	Flashing	--	--	--
BMS	Other faults of the battery management system	Flashing	--	--	--
BCP	Battery charging warning or protection	--	--	--	--
OVA	Output voltage abnormal	--	Inverter fast flashing	Alarm	On Solid
OVC	Output short circuit	--	Inverter fast flashing	Alarm	On Solid
OOL	Output overload	--	Inverter fast flashing	Alarm	On Solid
HOV	Hardware over voltage	--	--	--	--
MOV	Bus over voltage	--	--	--	--
MLV	Bus under voltage	--	--	--	--
IRE	Read EEPROM error	--	--	--	--

<i>IWE</i>	Write EEPROM error	--	--	--	--
<i>OTP</i>	Heat sink over temperature	--	--	--	--
<i>LTP</i>	Battery low temperature	--	--	--	--
<i>CF1</i>	Communication fault alarm	--	--	--	--
<i>UVN</i>	Utility over voltage	--	Utility fast flashing	Alarm	On Solid
<i>ULN</i>	Utility low voltage	--	Utility fast flashing	--	--
<i>UFA</i>	Utility frequency abnormal	--	Utility fast flashing	Alarm	On Solid
<i>PVN</i>	PV over voltage	--	PV charge fast flashing	Alarm	On Solid
<i>PDC</i>	PV over current	--	--	--	--
<i>PVA</i>	PV voltage abnormal	--	--	--	--
<i>PLL</i>	PV Power low	--	--	--	--
<i>POT</i>	PV over temperature	--	--	--	--

5.2 Solutions

Fault	Solution
Battery over voltage	Check whether the battery voltage is too high and disconnect the PV modules.
Battery over discharge	Waiting for the battery voltage to resume to or above LVR point (low voltage reconnect voltage) or changing the power supply method.
Battery overheating	When the battery temperature declines to the overheating recovery temperature or lower, the inverter/charger will resume working.
Device overheating	When the device temperature declines to the overheating recovery temperature or lower, the inverter/charger will resume working.
Output overload	① Please reduce the number of AC loads. ② Restart the device to recover the load output.
Output short circuit	① Check carefully loads connection, clear the fault. ② Restart the device to recover the load output.

6 Maintenance

1) The following inspections and maintenance tasks are recommended at least two times per year for the best performance.

- Make sure the inverter/charger is firmly installed in a clean and dry ambient.
- Make sure no block on airflow around the inverter/charger. Clear up any dirt and fragments on the radiator.
- Check all the naked wires to ensure insulation is not damaged for serious solarization, frictional wear, dryness, insects or rats, etc. Repair or replace some wires if necessary.
- Tighten all the terminals. Inspect for loose, broken, or burnt wire connections.
- Check and confirm that LED or LCD is consistent with the actual operating. Pay attention to any troubleshooting or error indication. Then, take the necessary corrective action.
- Confirm that all the system components are ground connected tightly and correctly.
- Confirm that all the terminals have no corrosion, insulation damaged, high temperature, or burnt/discolored sign. Then, tighten terminal screws to the suggested torque.
- Check for dirt, nesting insects, and corrosion. If so, clear up in time.
- Check and confirm the lightning arrester is in good condition. Replace a new one in time to avoid damaging the inverter/charger and even other equipment.



WARNING

Risk of electric shock! Ensure that all the power is turned off before the above operations, and then follow the corresponding inspections and operations.

2) The warranty does not apply under the following conditions:

- Damage is caused by improper use or use in an inappropriate environment.
- Battery voltage exceeds the input voltage limit of the inverter/charger
- Damage is caused by the working environment temperature exceeding the rated value.
- Unauthorized dismantling or attempted repair.
- Damage is caused by force majeure.
- Damage occurred during transportation or handling.

7 Specifications

Item	UP2000-HM6021	UP3000-HM10021	UP3000-HM5041	UP3000-HM8041
Rated battery voltage	24VDC		48VDC	
Battery input voltage	21.6~32VDC		43.2~64VDC	
Max. battery charging current	60A	100A	50A	80A
Inverter output				
Continuous output power	2000W	3000W	3000W	3000W
Max. surge power(3S)	4000W	6000W	6000W	6000W
Output voltage range	110VAC(-3%~+3%), 120VAC(-10%~+3%)			
Output frequency	50/60±0.2%			
Output wave	Pure Sine Wave			
Load power factor	0.2-1(Load power ≤ Continuous output power)			
Distortion THD	THD≤5%(Resistive load)			
80% rated output efficiency	89%	90%	91%	91%
Max. Rated output efficiency	88%	88%	90%	90%
Max. output efficiency	90%	92%	92%	92%
Switch time	10ms(Switch from the utility output to the inverter output), 15ms(Switch from the inverter output to the utility output)			
Utility charging				
Utility input voltage	88VAC~132VAC (Default), 80VAC~140VAC(Programmable)			
Utility input frequency	40~65Hz			
Max. utility charge current	60A	80A	40A	40A
Solar charging				

Max. PV open circuit voltage	250V ^① , 220V ^②			
MPPT voltage range	60~200V			
Max. PV input power	2000W	3000W	3000W	4000W
	(Note: For the curve of Max. PV input power Vs. PV open-circuit voltage, see chapter 3.4 Operating mode for details.)			
Max. PV charging power	1725W	2875W	2875W	4000W
Max. PV charging current	60A	100A	50A	80A
Equalize charging voltage	29.2V(AGM default)		58.4V(AGM default)	
Boost charging voltage	28.8V(AGM default)		57.6V(AGM default)	
Float charging voltage	27.6V(AGM default)		55.2V(AGM default)	
Low voltage disconnect voltage	21.6V(AGM default)		43.2V(AGM default)	
Tracking efficiency	≥99.5%			
Temp. compensate coefficient	-3mV/°C/2V(Default)			
General				
Surge current	50A	60A	56A	95A
Zero load consumption	<1.6A	<1.6A	<1.2A	<0.8A
	(without PV and utility connection, turn on the load output)			
Standby current	<1.2A	<1.0A	<0.7A	<0.6A
	(without PV and utility connection, turn off the load output)			
Mechanical Parameters				
Dimension(H x W x D)	607.5x381.6x127mm	642.5x381.6x149mm	642.5x381.6x149mm	642.5x381.6x149mm
Mounting size	585*300mm	620*300mm	620*300mm	620*300mm
Mounting hole size	Φ10mm	Φ10mm	Φ10mm	Φ10mm
Net Weight	15kg	19kg	19kg	19kg

① At minimum operating environment temperature

② At 25°C environment temperature

Item	UP2000-HM6022	UP3000-HM10022	UP3000-HM5042	UP5000-HM8042
Rated battery voltage	24VDC		48VDC	
Battery input voltage	21.6~32VDC		43.2~64VDC	
Max. battery charging current	60A	100A	50A	80A
Inverter output				
Continuous output power	2000W	3000W	3000W	5000W
Max. surge power(3S)	4000W	6000W	6000W	8000W
Output voltage range	220VAC(-6%~+3%), 230VAC(-10%~+3%)			
Output frequency	50/60±0.2%			
Output wave	Pure Sine Wave			
Load power factor	0.2-1(Load power ≤ Continuous output power)			
Distortion THD	THD≤3%(Resistive load)			
80% rated output efficiency	92%	92%	92%	92%
Max. Rated output efficiency	91%	91%	90%	91%
Max. output efficiency	93%	93%	93%	93%
Switch time	10ms(Switch from the utility output to the inverter output), 15ms(Switch from the inverter output to the utility output)			
Utility charging				
Utility input voltage	176VAC~264VAC (Default), 90VAC~280VAC(Programmable)			
Utility input frequency	40~65Hz			
Max. utility charge current	60A(When the Utility input voltage is 90VAC~180VAC, the Max. utility charge current is 30A)	80A(When the Utility input voltage is 90VAC~180VAC, the Max. utility charge current is 40A)	40A(When the Utility input voltage is 90VAC~180VAC, the Max. utility charge current is 20A)	60A(When the Utility input voltage is 90VAC~180VAC, the Max. utility charge current is 30A)

Solar charging				
Max. PV open circuit voltage	450V ^① , 395V ^②			500V ^① 440V ^②
MPPT voltage range	80~350V			120~400V
Max. PV input power	2500W	4000W	4000W	4000W
	(Note: For the curve of Max. PV input power Vs. PV open-circuit voltage, see chapter 3.4 Operating mode for details.)			
Max. PV charging power	1725W	2875W	2875W	4000W
Max. PV charging current	60A	100A	50A	80A
Equalize charging voltage	29.2V(AGM default)		58.4V(AGM default)	
Boost charging voltage	28.8V(AGM default)		57.6V(AGM default)	
Float charging voltage	27.6V(AGM default)		55.2V(AGM default)	
Low voltage disconnect voltage	21.6V(AGM default)		43.2V(AGM default)	
Tracking efficiency	≥99.5%			
Temp. compensate coefficient	-3mV/°C/2V(Default)			
General				
Surge current	50A	60A	56A	95A
Zero load consumption	<1.8A		<1.2A	
	(without PV and utility connection, turn on the load output)			
Standby current	<1.2A		<0.7A	
	(without PV and utility connection, turn off the load output)			
Mechanical Parameters				
Dimension(H x W x D)	607.5x381.6x127mm	642.5x381.6x149mm	607.5x381.6x149mm	642.5x381.6x149mm
Mounting size	585*300mm	620*300mm	585*300mm	620*300mm
Mounting hole size	Φ10mm	Φ10mm	Φ10mm	Φ10mm
Net Weight	15kg	19kg	18kg	19kg

① At minimum operating environment temperature

② At 25°C environment temperature

Environment Parameters

Enclosure	IP30
Relative humidity	< 95% (N.C.)
Environment temperature	-20°C~50°C
Storage temperature	-25°C~60°C
Altitude	<5000m(If the altitude exceeds 1000 meters, the actual output power is reduced according to IEC62040.)

8 Appendix 1 Disclaimers

The warranty does not apply to the following conditions:

- Damage is caused by improper use or an inappropriate environment.
- Load current/voltage/power exceeds the limit value of the inverter/charger.
- Damage caused by working temperature exceeds the rated range.
- Arc, fire, explosion, and other accidents are caused by failure to follow the inverter/charger stickers or manual instructions.
- Disassemble and repair the inverter/charger without authorization.
- Damage is caused by force majeure.
- Damage occurred during transportation or handling.

Any changes without prior notice! Version number: V2.1

HUIZHOU EPEVER TECHNOLOGY CO., LTD.

Beijing Tel: +86-10-82894896/82894112

Huizhou Tel: +86-752-3889706

E-mail: info@epever.com

Website: www.epever.com