



MPPT Dual Battery Solar Charge Controller

User Manual



DR1106N-DDB/DDS DR1206N-DDB/DDS
DR2106N-DDB/DDS DR2206N-DDB/DDS
DR3106N-DDB/DDS DR3206N-DDB/DDS
DR2210N-DDB/DDS DR3210N-DDB/DDS

Important Safety Instructions

Please reserve this manual for future review.

This manual contains all the safety, installation, and operation instructions for the DuoRacer series MPPT Dual Battery Solar Charge Controller (referred to as the controller in the next contents).

- Read all the instructions and warnings carefully before installation.
- No user-serviceable components exist inside the controller. Do NOT disassemble or attempt to repair the controller.
- Avoid direct sunlight and high temperature, and do NOT install the controller at locations where water can get in.
- Install the controller in well-ventilated places; the controller's heat sink may become very hot during the system operation.
- Do not install the controller in humid, salt spray, corrosion, greasy, flammable, explosive, dust accumulative, or other severe environments.
- Appropriated external fast-acting fuses or breakers are suggested.
- Please cut off all PV array connections, and disconnect the fast-acting fuses or breakers close to the battery before the controller installation and adjustment.
- Power connections must remain tight to avoid excessive overheating from the loose connection.

CONTENTS

1 General Information	1
1.1 Overview	1
1.2 Naming Rule	3
1.3 Appearance	3
1.4 Battery charging stage	4
1.5 Starter battery BATT2	6
1.6 AES Signal Port	7
2 Installation	10
2.1 Attentions	10
2.2 PV Array Requirements	10
2.3 Wire Size	11
2.4 Mounting	13
3 Display units	17
3.1 DuoRacer Display Basic (DDB)	17
3.2 DuoRacer Display Standard (DDS)	19
4 Others	27
4.1 Protections	27
4.2 Troubleshooting	28
4.3 Maintenance	30
5 Specifications	31
Annex I Dimension Diagrams	34

1 General Information

1.1 Overview

DuoRacer MPPT charge controller is designed for charging two batteries (shown as the main battery (BATT1) and starter battery (BATT2) below) at the same time in a solar system. This controller, supporting multiple main batteries (BATT1), including Sealed, Gel, Flooded, LiFePO4, and Li-NiCoMn, is suitable for the RV, Camper, Boat, and so on. The device automatically recognizes the starter battery (BATT2) system voltage and charges the battery when the conditions are satisfied.

The controller adopts the advanced MPPT control algorithm, which will minimize the maximum power point loss rate and loss time, fast-track the maximum power point (MPP) of the PV array, and obtain the maximum energy of the solar array under any conditions. The energy utilization in the MPPT solar system is increased by 20-30% compared with the PWM charging method.

When there is no operation for a long time and the charging conditions cannot be satisfied, the controller switches to the low-power mode. It helps reduce self-consumption and saves the battery power to enhance the product's life. The system parameters are shown and set by LED/LCD or the MT11 remote meter (Accessory).

The AES control signal of the car refrigerator is built into the controller, which will supply the surplus solar power to the refrigerator to avoid energy waste. The controller has an IP33 protection level, which is waterproof and dustproof. Multiple protection features, including battery overcharge protection, over-discharge protection, and reverse connection protection of the PV and battery, ensure the solar system's safety, stability, and lifetime.

Features:

- Maximum Power Point Tracking technology with ultra-fast tracking speed and the tracking efficiency is no less than 99.5% guaranteed
- Advanced MPPT control algorithm to minimize the MPP lost rate and time
- The wider range of the MPP operation voltage to improve the PV module utilization

- Auto-control function of charging power & charging current limitation(BATT1)
 - High quality and low failure rate components of ST, TI, and Infineon to ensure the product life
 - Digital circuit control of adaptive three-stage charging mode to enhance BATT1 life.
 - BATT1 type can be set via LED/LCD.
 - The product runs into the low-power mode when there is no manual operation for a long time and charging conditions are not satisfied (PV<5V).
 - 100% charging and discharging in operation environmental temperature range.
 - Optional LED and LCD units.
 - AES control signal for car refrigerators to avoid energy waste.
 - Standard Modbus protocol and RS485 (5V/200mA) communication port for the customer to expand the application area.
- ① **Main battery (BATT1) is the energy storage battery for powering the household loads in the off-grid system, supporting Sealed, Gel, Flooded, LiFePO4, and Li-NiCoMn batteries. The controller can NOT automatically identify the system voltage.**
- ② **Starter battery (BATT2), built in the vehicle, is the energy storage battery for powering systems such as RVs and boats. It only supports a lead-acid battery, and the controller can automatically identify the system voltage.**

 CAUTION	The BATT1 and BATT2 must be at the same voltage level.
--	--

1.2 Naming Rule

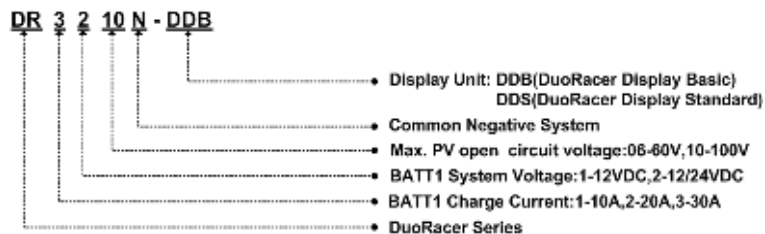

1.3 Appearance



①	Mounting hole sizeΦ5mm	⑥	BATT1 terminals
②	LCD(Refer to chapter 3)	⑦	BATT2 terminals
③	Grounding Terminal	⑧	RS485 Communication port ⁽²⁾
④	Remote temperature sensor ⁽¹⁾ port	⑨	AES (signal) output port ⁽²⁾
⑤	PV terminals	⑩	Terminal protection cover

(1) The controller charges the BATT1 as default (25°C) when it's not connected to the remote temperature sensor or the temperature sensor is damaged.

The temperature compensation is **ONLY** designed for the lead-acid battery. For lithium batteries, there is no temperature compensation.

- (2) For DR1106/2106/3106N models, AES port (outputs 12V/200mA) and RS485 port(outputs 5V/200mA) are independent. The 12V output voltage is the battery voltage.

For DR1206/2206/3206/2210/3210N models, the AES port and RS485 port share the power of 5VDC/Max. 200mA.

The AES signal port is designed for car refrigerators supporting the AES signal. It is built into a power switching device.

1.4 Battery charging stage

Note: The following instructions for the battery charging stage are suitable for the main battery (BATT1). Charging instructions for the starter battery (BATT2) refer to chapter 1.5.

The controller has a three-stage battery charging algorithm, including Bulk Charging, Constant Charging, and Float Charging. The system can extend the battery's lifespan through the three-stage charging method.

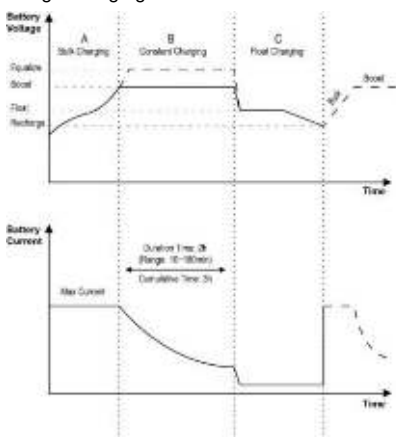

Figure 1-4 Battery charging stage curve

a) Bulk Charging

The battery voltage has not yet reached the constant voltage (Equalize or Boost Charging Voltage). The controller operates in constant current mode, delivering its

maximum current to the batteries (MPPT Charging). When the battery voltage reaches the constant voltage set point, the controller will start to operate in constant charging mode.



b) Constant Charging

When the battery voltage reaches the constant voltage set point, the controller will start to operate in constant charging mode. The MPPT charging stops during this process, and the charging current will drop gradually simultaneously. Constant charging has two stages, namely, equalize charging and boost charging. These two charging processes are not repeated. Among them, equalized charging starts on the 28th of each month.

➤ **Boost Charging**

The default duration of the boost charging stage is generally 2 hours. Customers can adjust the constant time and preset value according to actual needs. The system will switch to the float charging stage when the duration equals the set value.

➤ **Equalize Charging**

 WARNING	Explosive Risk! Equalizing flooded batteries would produce explosive gases, so well ventilation of the battery box is recommended.
 CAUTION	<ul style="list-style-type: none">• Equipment damage!• Equalization may increase battery voltage to the level that damages sensitive DC loads. Verify that the load's allowable input voltages are greater than the equalizing charging voltage.• Over-charging and excessive gas precipitation may damage the battery plates and activate material shedding on them. Too high an equalized charging or for too long may cause damage. Please carefully review the specific requirements of the battery used in the system.

Some battery types benefit from equalizing charging, stirring electrolytes, balancing battery voltage, and accomplishing chemical reactions. Equalize charging increases the battery voltage to make it higher than the standard complement voltage, gasifying the battery electrolyte.

If the controller automatically controls the next charge for equalizing charging, the equalizing charging time is 120 minutes. Equalize and boost charges are not carried out constantly in a full charge process to avoid too much gas precipitation or overheating of the battery.

 CAUTION	<ul style="list-style-type: none"> • Due to the installation environment or load work, the system may not stabilize the battery voltage at a constant voltage. The controller will accumulate the time when the battery voltage is equal to the set value. When the accumulative time equals 3 hours, the system will automatically switch to float charging. • If the controller time is not adjusted, the controller will equalize charging following the inner time.
---	---

c) Float Charging

After the constant charging stage, the controller will reduce the battery voltage to the float charging preset voltage by reducing the charging current. During the floating charge stage, the battery is charged weakly to ensure that the battery is maintained in a fully charged state. In the float charging stage, loads can obtain almost all power from the solar panel. Suppose loads' power exceeds the solar array's power. In that case, the controller will no longer maintain the battery voltage in the float charging stage. When the battery voltage goes lower than the boost voltage reconnect voltage, the system will exit the float charging stage and enter the bulk charging stage again.

1.5 Starter battery BATT2

1) Working principle

The controller trickle charges the BATT2 at 1A constant current. When the voltage reaches the "Full voltage" during the BATT2 charging process, the controller will stop charging and exit from the constant voltage charging mode.

2) Voltage parameters

Item	Default	Modify range
Full voltage	13.8V/12V; 27.6V/24V	9~17V(24V×2)
Charge return voltage	13V/12V; 26V/24V	9~17V(24V×2)

 CAUTION	Please follow the logic of Full Voltage > Return Voltage when modifying the voltage point.
---	--

3) Start charging conditions

 CAUTION	BATT2 ONLY supports lead-acid battery types. Before starting the BATT2 charging, please connect the BATT1 first.
---	--

Condition1: BATT2 starts charging when BATT1 reaches the float charging stage, and the BATT2 voltage is lower than the "Charging Return Voltage."

Condition 2: BATT2 starts charging when the battery's total charging current is higher than 3A and the BATT2 voltage is lower than the "Charging Return Voltage."

4) Stop Charging Conditions

Condition 1: BATT2 stops charging when the PV voltage is no higher than 2V of the BATT1.

Condition 2: BATT2 stops charging when BATT1 is not in the float charging stage and the total charging current for the battery is less than 2.5A.

Condition 3: BATT2 stops charging when BATT2 reaches the "Full Voltage."

 CAUTION	After the BATT2 charging is turned off, it will be recharged only when the start charging conditions are satisfied.
---	---

5) Starter Battery (BATT2) Charging indication

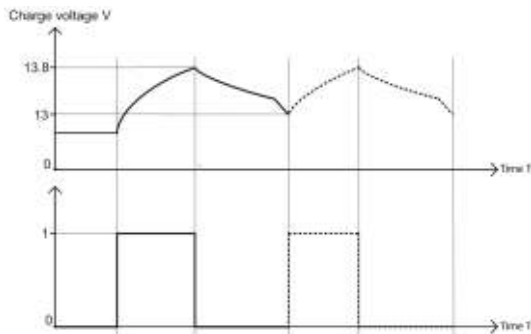

1.6 AES Signal Port

1) AES port working principle

- The AES signal is turned on after the BATT1 voltage reaches the Boost Charging Voltage or Equalize Charging Voltage for 5 minutes.
- The controller checks if the BATT1 charges in the boost, equalize, or float stage every 5 minutes. The interval is the delay time for turning off the AES signal, set via PC software (default 5 minutes, ranging from 0 to 999 minutes). The AES signal control is turned off if the BATT1 is not in the charging stage five times.

2) AES port of DR1106/2106/3106N-DDB/DDS

The AES port and the RS485 port are independent. The AES port output is 12V/200mA, and the voltage is the battery voltage. Connect the refrigerator. Refer to the below picture.



3) AES signal port of DR1206/2206/3206/2210/3210N-DDB/DDS

The AES signal port and RS485 port share the power of 5VDC/Max.200mA. Connect the accessories (AES-ADP adapter) when connecting the refrigerator; refer to the below picture.



The AES signal port and RS485 port share the power of 5VDC/Max.200mA. The MT11 power consumption is 13mA when it is ON and 4mA when it's off.

4) (Optional) AES-ADP adapter

The AES-ADP adapter converts the 5V-AES signal of the solar controller into a 12V-AES signal for the refrigerator. AN AES-ADP ADAPTER IS NECESSARY when DR1206/2206/3206/2210/3210N-DDB/ DDS connects the refrigerator.

• Appearance



No.	Interface	Instructions
①	Input terminal	Connect to the controller's AES Sig. terminal and the BATT1 output terminal
②	Output terminal	Connect to the refrigerator's AES signal terminal
③	Power indicator	Indicate BATT1 power ON
④	AES signal indicator	Light on with an AES signal Light off without an ASE signal

• **Main Parameters**

Applicable	DR1206/2206/3206/2210/3210N-DDB/DDS
Input Voltage	8.5V-35V
Output Voltage	12V/200mA
Self-consumption	1mA@12V; 1.5mA@24V
Environment temperature	-30°C ~ +60°C
Features	Support output short-circuit, BATT1 input terminal reversed polarity, and AES signal reversed connection

2 Installation

2.1 Attentions

- Do not install the controller in humid, salt spray, corrosion, greasy, flammable, explosive, dust accumulative, or other severe environments.
- Be very careful when installing the batteries, especially flooded lead-acid batteries. Wear eye protection, and have fresh water to rinse if there is any contact with battery acid.
- Keep the battery away from any metal objects, which may cause a short circuit of the battery.
- Explosive battery gases may come out from the battery during charging, so make sure the ventilation condition is good.
- For outdoor installation, keep out of the direct sunshine and rain infiltration.
- Loose connections and corroded wires may produce high heat that can melt wire insulation, burn surrounding materials, or even cause a fire. Ensure tight connections, use cable clamps to secure cables, and prevent them from swaying in the mobile application.
- The controller can work with lead-acid and lithium batteries within its control scope.
- The battery connection may be wired to one battery or a bank of batteries. The following instructions refer to a singular battery. However, it is implied that the battery connection can be made to either one battery or a group of the battery bank.
- Select the system connection cables according to the current density no greater than $5\text{A}/\text{mm}^2$.

2.2 PV Array Requirements

Serial connection (string) of PV modules

As the core component of the solar system, the controller could be suitable for various types of PV modules and maximize converting solar energy into electrical energy. The series number of different PV modules can be calculated according to the open-circuit voltage (V_{oc}) and the maximum power point voltage (V_{mpp}) of the MPPT controller. The below table is for reference only.

DR1106/2106/3106/1206/2206/3206N-DDB/DDS:

System voltage	36cell Voc<23V		48cell Voc<31V		54cell Voc<34V		60cell Voc<38V	
	Max.	Best	Max.	Best	Max.	Best	Max.	Best
12V	2	2	1	1	1	1	1	1
24V	2	2	-	-	-	-	-	-

System voltage	72cell Voc<46V		96cell Voc<62V		Thin-Film module Voc>80V
	Max.	Best	Max.	Best	
12V	1	1	-	-	-
24V	1	1	-	-	-

NOTE: The above parameter values are calculated under standard test conditions (STC(Standard Test Condition): Irradiance 1000W/m², Module Temperature 25°C, Air Mass 1.5.)

DR2210/3210N-DDB/DDS:

System voltage	36cell Voc<23V		48cell Voc<31V		54cell Voc<34V		60cell Voc<38V	
	Max.	Best	Max.	Best	Max.	Best	Max.	Best
12V	4	2	2	1	2	1	2	1
24V	4	3	2	2	2	2	2	2

System voltage	72cell Voc<46V		96cell Voc<62V		Thin-Film module Voc>80V
	Max.	Best	Max.	Best	
12V	2	1	1	1	1
24V	2	1	1	1	1

NOTE: The above parameter values are calculated under standard test conditions (STC(Standard Test Condition): Irradiance 1000W/m², Module Temperature 25°C, Air Mass 1.5.)

2.3 Wire Size

The wiring and installation methods must conform to national and local electrical code requirements.

➤ PV Wire Size

Since the PV output current varies with the PV module's size, connection method, or sunlight angle, the minimum wire size can be calculated by the PV I_{sc} . Please refer to the value of I_{sc} in the PV module specification. When PV modules are connected in series, the I_{sc} equals each PV module's I_{sc} . When PV modules are connected in parallel, the I_{sc} equals the sum I_{sc} of the PV modules. The I_{sc} of the PV array must not exceed the controller's maximum PV input current. Please refer to the table below:

NOTE: All PV modules in a given array are assumed to be identical.

I_{sc} ★=Short circuit current (amps) V_{oc} = Open circuit voltage

Model	Max. PV input current	Max. PV wire size
DR1106N-DDB/DDS DR1206N-DDB/DDS	10A	4mm ² /12AWG
DR2106N-DDB/DDS DR2206N-DDB/DDS DR2210N-DDB/DDS	20A	6mm ² /10AWG
DR3106N-DDB/DDS DR3206N-DDB/DDS DR3210N-DDB/DDS	30A	10mm ² /8AWG

 CAUTION	When the PV modules are connected in series, the open-circuit voltage of the PV array must not exceed 46V(DR**06N-DDB/DDS),92V (DR**10N-DDB/DDS).
---	---

➤ Battery and load wire size



The battery and load wire size must conform to the rated current. The reference size is as below:

Model	Rated Charge Current	Battery wire size
DR1106N-DDB/DDS DR1206N-DDB/DDS	10A	4mm ² /12AWG
DR2106N-DDB/DDS DR2206N-DDB/DDS DR2210N-DDB/DDS	20A	6mm ² /10AWG
DR3106N-DDB/DDS	30A	10mm ² /8AWG

DR3206N-DDB/DDS		
DR3210N-DDB/DDS		

 CAUTION	<ul style="list-style-type: none"> The wire size is only for reference. Suppose a long distance exists between the PV array and the controller or between the controller and the battery. Larger size wires can be used to reduce the voltage drop and improve performance. The battery cable size recommendations assume that the charge controller is the only device connected to this cable (no inverter connected to the same cable etc.).
---	---

2.4 Mounting

 WARNING	<ul style="list-style-type: none"> Risk of explosion. Never install the controller in a sealed enclosure with flooded batteries. Do not install in a confined area where battery gas can accumulate. Risk of electric shock. Disconnect the breaker before wiring because the PV array may generate a high open-circuit voltage.
 CAUTION	<p>The controller requires at least 150mm of clearance above and below for proper airflow. Ventilation is highly recommended if mounted in an enclosure.</p>

Installation steps:

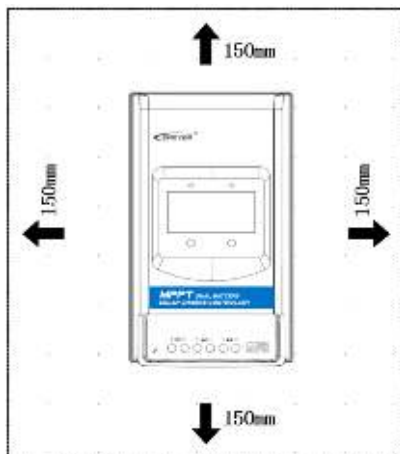

Step1: Determine the installation location and heat-dissipation space



The controller shall be installed with sufficient airflow through the controller's radiators. The minimum clearance is 150mm from the upper and lower edges to ensure natural thermal convection.

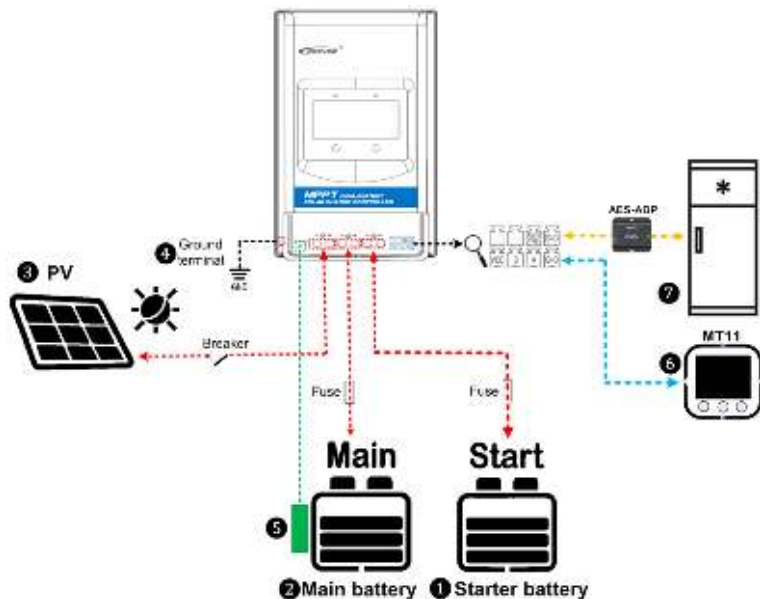

Ensure that the controller can dissipate heat if installed in a closed area. Suppose the controller is to be installed in an enclosed box. In that case, ensuring reliable heat dissipation through the box is important.



Step2: Wiring ①②③

Connect the system in the order of ① Starter battery BATT2  → ② Main battery BATT1  → ③ PV array  by the above diagram and disconnect the system in the reverse order ③②①.



- The BATT1 and BATT2 must be set at the same voltage level, and other situations are not supported for the moment.
- Follow the above instruction for wiring. Otherwise, it may cause

	<p>the BATT2 system voltage identification error.</p> <ul style="list-style-type: none"> • While wiring the controller, do NOT connect the breaker or fast-acting fuse. Ensure that the electrode polarity is correctly connected. • A fast-acting fuse whose current is 1.25 to 2 times the rated current of the controller must be installed on the battery side with a distance from the battery not greater than 150mm. • If an inverter is connected to the system, connect the inverter directly to the battery.
--	---

Step3: Grounding ④

DR N series is a common-negative controller. All the negative terminals of the PV array and battery can be grounded simultaneously, or any one of the negative will be grounded. However, according to the practical application, all the negative terminals of the PV array and battery needn't be grounded. However, the grounding terminal on the controller's shell must be grounded. It may effectively shield the electromagnetic interference from the outside and prevent electric shock to the human body.

 CAUTION	<p>A common-negative controller for common-negative systems, such as a motorhome, is recommended. However, the controller may be damaged if some common-negative equipment is used and its positive electrode is grounded in the common-negative system.</p>
---	--

Step4: Connect the remote temperature sensor cable ⑤



Temperature sensor
(Model:RT-MF58R47K3.81A)



Remoter temperature sensor
(Model:RTS300R47K3.81A)

Connect the remote temperature sensor cable to the port ④ and place the other end close to the BATT1.

 CAUTION	<p>Suppose the remote temperature sensor is not connected to the controller. In that case, the default temperature for battery charging or discharging is 25°C without temperature compensation.</p>
---	--

Step5: Connect the remote meter MT11 ⑥ and AES signal of the refrigerator ⑦

DR1106/2106/3106N-DDB/DDS:

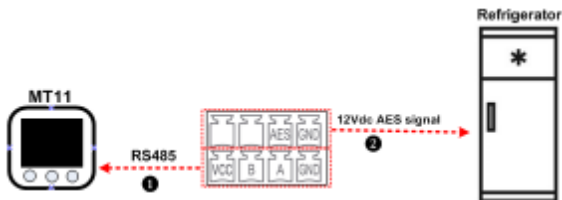

DR1206/2206/3206/2210/3210N-DDB/DDS:

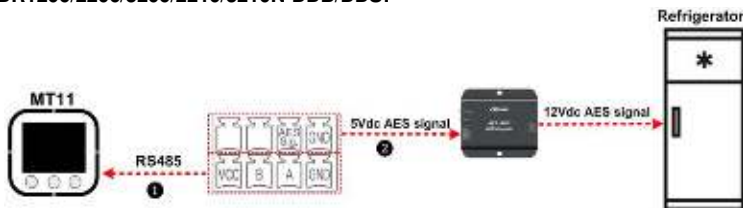

① RS485 Communication cable

CC-RS485-RS485-3.81-4P-150 (Included)

CC-RS485-RS485-3.81-4P-1000 (Optional)

CC-RS485-RS485-3.81-4P-2000 (Optional)

The remote meter operations refer to the MT11 user manual.

The controller only provides one AES signal control. A practical consideration is needed for the specific application (Check the "1.5 AES Signal output port instruction" for more information).

Step6: Power on the controller

- 1) Firstly, turn on the BATT2 safety switch and check the BATT2 charging indicator status.
- 2) Then, turn on the BATT1 safety switch and check the BATT1 charging indicator status (Check the "3. Display Units" for more information).
- 3) Lastly, connect the PV array circuit breaker.









If the controller is not operating properly or the battery indicator on the controller shows an abnormality, please refer to 4.2 "Troubleshooting."

3 Display units

3.1 DuoRacer Display Basic (DDB)



(1) Status indicator

Indicator	Color	Status	Instruction
	Green	OFF	No charging
	Green	Slowly flashing (1Hz)	Charging, in Boost or Equalize charging stage
	Green	On solid	Full, in Float charging stage
	Red	OFF	BATT1 Temperature normal
	Red	Fast flashing (4Hz)	BATT1 over-temperature or BATT1 low temperature
	Green	On solid	Connect to BATT1 and in charging
	Green	Slowly flashing (0.2Hz)	Connect to BATT1 and no charging
	Green	OFF	Not connect BATT1
	Red	On solid	BATT1 over-discharged/Low voltage
	Red	OFF	BATT1 low voltage reconnect
	Green	On solid	AES signal is ON
	Green	OFF	AES signal is OFF
	Green	On solid	Connect to BATT2 and in charging
	Green	Slowly flashing(1Hz)	Connect to BATT2 and no charging
	Green	OFF	Not connect BATT2

	Green	On solid	In the mode of setting battery type
	Green	OFF	Settings are saved, and quit the setting mode
All indicators fast flashing(4Hz)			System voltage error ^①
All indicators slowly flashing(1Hz)			Controller overheating

① The controller cannot identify the system voltage when the battery type is a lithium battery



Indicator "OFF".



Indicator "On solid".







Indicator "Slowly flashing (1Hz)".



Indicator "Slowly flashing (0.2Hz)".

(2) Battery type indicator

Indicator	Color	Status	Instruction
 Sealed	Green	On solid	12V system
		Flashing	24V system ^①
 Gel	Red	On solid	12V system
		Flashing	24V system ^①
 Flooded	Green	On solid	12V system
		Flashing	24V system ^①
 LiFePO ₄	Red	On solid	12V system
		Flashing	24V system ^①
 Li-NiCoMn	Green	On solid	12V system
		Flashing	24V system ^①

①The models of DR1106/2106/3106N-DDB/DDS don't support the 24V battery.

Setting battery type:

Step1: Press the button and hold 3s; the green  is on solid. Enter the battery setting mode.

Step2: Press the button to select the battery type.

Step3: Wait for 5 seconds until the setting indicator turns off. The battery type is set successfully.

3.2 DuoRacer Display Standard (DDS)

























Note: The display screen can be viewed clearly when the angle between the end-users horizontal sight and the display screen is within 90°. If the angle exceeds 90°, the information on the display screen cannot be viewed clearly.

- **Charging indicator**

Indicator	Color	Status	Instruction
	Green	On solid	PV charges the battery with a low current
	Green	OFF	1. No sunlight 2. Connection error 3. Low PV voltage
	Green	Slowly flashing(1Hz)	Normal charging
	Green	Fast flashing(4Hz)	PV overvoltage

- **Operation interface**



Icon	Instruction	Icon	Instruction
	BATT1 battery capacity ^① 0~12%		BATT2 battery capacity ^① 0~12%

	BATT1 battery capacity ^① 13%~35%		BATT2 battery capacity ^① 13%~35%
	BATT1 battery capacity ^① 36%~61%		BATT2 battery capacity ^① 36%~61%
	BATT1 battery capacity ^① 62%~86%		BATT2 battery capacity ^① 62%~86%
	BATT1 battery capacity ^① 87%~100%		BATT2 battery capacity ^① 87%~100%
	Day		PV array
	Night		BATT1 charging icon
	Display the parameters of PV		BATT2 charging icon
	Display the parameters of BATT1		BATT1 temperature parameters
	Display the parameters of BATT2	AES	AES signal icon
	Setting icon	Batt. Type	Battery type icon
	Auto global browsing icon	Min.	Minimum voltage icon
	Fault Icon	Max.	Maximum voltage icon

① The linear relationship between the LVD voltage and float charging voltage calculates the battery capacity.



• Fault indication

Fault	Fault indicator	Charge indicator	LCD	Instruction
BATT1 overvoltage	Red Fast flashing	—		Battery capacity shows full, battery frame blink, fault icon

				blink.
BATT1 over-discharge	—	—		Battery capacity shows empty, battery frame blink, fault icon blink.
BATT1 over temperature	Red Fast flashing	—		The battery frame, fault icon, the temperature icon, the temperature value, and the temperature unit is blinking.
BATT1 system voltage error ^①	Red Fast flashing	Green Fast flashing		Battery capacity shows empty, battery frame blink. Fault icon blinks, and battery frame blink



① No alarm for system voltage error when BATT1 is a lithium battery.

• Buttons

	Press the button	Parameters of PV array Parameters of BATT1 Parameters of BATT2 Auto global browsing mode(<i>Auto</i>)
	Press the button	Browse the PV array parameters Browse the BATT1 parameters Browse the BATT2 parameters
	Press the button and hold on 5s	Select the temperature unit Select the battery type

(1) Auto global browsing mode

Operation:

Press the  button until *Auto* is appear. Then press the  button,  appears. Now it is set as auto global browsing mode.

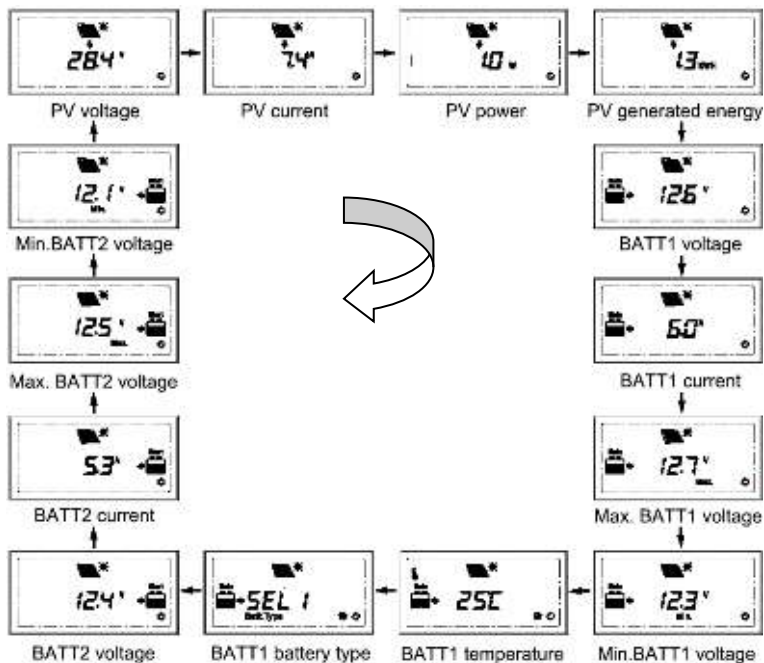

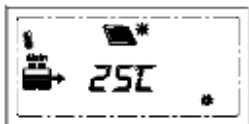

Loop display: PV voltage → PV current → PV power → PV generated energy → BATT1 voltage → BATT1 current → Max. BATT1 voltage → Min. BATT1 voltage → BATT1 temperature → BATT1 battery type → BATT2 voltage → BATT2 current → Max. BATT2 voltage → Min. BATT2 voltage → PV voltage → ……

(2) Change Temperature units



Operation:



Step1: Press the  button under the battery temperature interface until the symbol flashes.

Step2: Press the  button to select the temperature unit.

Step3: Press the  button to set successfully.

(3) Clear the generated energy



Press the  and  button simultaneously and hold on for 5s to clear the generated energy.

(4) Change Battery type



Operation:

Step1: In the battery type interface, press the  button and hold on for 5s until the symbol flashes.

Step2: Press the  button to select the battery type.

Step3: Press the  button to confirm the battery type.

Battery type:

<i>SEL 1</i>	BATT112V Sealed	<i>SEL 2</i>	BATT124V Sealed ^①
<i>GEL 1</i>	BATT112V Gel	<i>GEL 2</i>	BATT124V Gel ^①
<i>FLd 1</i>	BATT112V Flooded	<i>FLd 2</i>	BATT124V Flooded ^①
<i>LIF4</i>	LiFePO ₄ (4S)	<i>LIF8</i>	LiFePO ₄ (8S) ^①
<i>LIC3</i>	Li-NiCoMn (3S)	<i>LIC6</i>	Li-NiCoMn (6S) ^①
<i>USE</i>	User		

^①The models of DR1106/2106/3106N-DDB/DDS don't support the 24V battery.

 CAUTION	<ul style="list-style-type: none"> The battery control voltage parameters cannot be modified when the battery is set as the default battery type. If you want to modify the control parameters, please select the battery type as "User." The control parameters can only be set via PC software or mobile
---	--

APP under the "User" battery type.

1) Lead-acid Battery Voltage Parameters

The parameters are in the 12V system at 25 °C; please double the values in the 24V system.

Battery type Voltage parameter	Sealed	Gel	Flooded	User
Over Voltage Disconnect Voltage	16.0V	16.0V	16.0V	9~17V ^①
Charging Limit Voltage	15.0V	15.0V	15.0V	
Over Voltage Reconnect Voltage	15.0V	15.0V	15.0V	
Equalize Charging Voltage	14.6V	—	14.8V	
Boost Charging Voltage	14.4V	14.2V	14.6V	
Float Charging Voltage	13.8V	13.8V	13.8V	
Boost Reconnect Charging Voltage	13.2V	13.2V	13.2V	
Low Voltage Reconnect Voltage	12.6V	12.6V	12.6V	
Under Voltage Warning Reconnect Voltage	12.2V	12.2V	12.2V	
Under Volt. Warning Volt.	12.0V	12.0V	12.0V	
Low Volt. Disconnect Volt.	11.1V	11.1V	11.1V	
Discharging Limit Voltage	10.6V	10.6V	10.6V	
Equalize Duration (min.)	120	—	120	0~180
Boost Duration (min.)	120	120	120	10~180

① The DR1106/2106/3106N-DDB/DDS voltage is 9-16V.

The following rules must be observed when modifying the parameter's value in user battery type (factory default value is the same as sealed type):

- A. Over Voltage Disconnect Voltage > Charging Limit Voltage ≥ Equalize Charging Voltage ≥ Boost Charging Voltage ≥ Float Charging Voltage > Boost Reconnect Charging Voltage.
- B. Over Voltage Disconnect Voltage > Over Voltage Reconnect Voltage
- C. Low Voltage Reconnect Voltage > Low Voltage Disconnect Voltage ≥ Discharging Limit Voltage.
- D. Under Voltage Warning Reconnect Voltage > Under Voltage Warning Voltage ≥ Discharging Limit Voltage.
- E. Boost Reconnect Charging voltage > Low Voltage Reconnect Voltage.

2) Lithium Battery Voltage Parameters

The parameters are in the 12V system at 25 °C; please double the values in the 24V system.

Battery type Voltage parameter	LiFePO ₄ (4S)	Li-NiCoMn (3S)	User
Over Voltage Disconnect Voltage	15.6V	13.5V	9~17V ^①
Charging Limit Voltage	14.6V	12.6V	
Over Voltage Reconnect Voltage	14.5V	12.5V	
Equalize Charging Voltage	14.5V	12.5V	
Boost Charging Voltage	14.5V	12.5V	
Float Charging Voltage	13.8V	12.2V	
Boost Reconnect Charging Voltage	13.2V	12.1V	
Low Voltage Reconnect Voltage	12.4V	10.5V	
Under Voltage Warning Reconnect Voltage	12.5V	11.0V	
Under Volt. Warning Volt.	12.0V	10.5V	
Low Volt. Disconnect Volt.	11.0V	9.3V	
Discharging Limit Voltage	10.8V	9.3V	

① The DR1106/2106/3106N-DDB/DDS voltage is 9-16V.

The following rules must be followed when modifying the value of a lithium battery.

- A. Over Voltage Disconnect Voltage > Over charging protection voltage (Protection Circuit Modules (BMS)) + 0.2V*;
- B. Over Voltage Disconnect Voltage > Over Voltage Reconnect Voltage = Charging Limit Voltage ≥ Equalize Charging Voltage = Boost Charging Voltage ≥ Float Charging Voltage > Boost Reconnect Charging Voltage;
- C. Low Voltage Reconnect Voltage > Low Voltage Disconnect Voltage ≥ Discharging Limit Voltage;
- D. Under Voltage Warning Reconnect Voltage > Under Voltage Warning Voltage ≥ Discharging Limit Voltage;
- E. Boost Reconnect Charging voltage > Low Voltage Reconnect Voltage;
- F. Low Voltage Disconnect Voltage ≥ Over discharging protection voltage (BMS) + 0.2V*.



WARNING

- Refer to the lithium battery BMS voltage parameters to set the lithium battery voltage parameters.
- The required accuracy of BMS shall be at least 0.2V. If the deviation exceeds 0.2V, the manufacturer will assume no liability for any system malfunction caused by this.



4 Others









4.1 Protections

PV Over Current/Power	When the charging current or power of the PV array exceeds the controller's rated current or power, it will change at the rated current or power.
PV Short Circuit	When not in the PV charging state, the controller will not be damaged in case of a short-circuiting in the PV array.
PV Reverse Polarity	When the polarity of the PV array is reversed, the controller may not be damaged and can continue to operate normally after the polarity is corrected. NOTE: If the PV array is reversed and the actual power is 1.5 times the rated controller's power, the controller will be damaged.
Night Reverse Charging	Prevent the battery from discharging to the PV module at night.
BATT1 and BATT2 Reverse Polarity	When the polarity of the battery is reversed, the controller may not be damaged and resume normal operation after the mis-wiring is corrected. NOTE: Limited to the lithium battery's characteristic, when the PV connection is correct, either the BATT1 or BATT2 battery connection reversed, the controller will be damaged.
BATT1 Over Voltage	When the battery voltage reaches the over voltage disconnect voltage, it will automatically stop battery charging to prevent battery damage caused by over-charging.
BATT1 Over Discharge	When the battery voltage reaches the low voltage disconnect voltage, it will automatically stop battery discharging to prevent battery damage caused by over-discharging. (Any controller connected to the loads will be disconnected. Loads directly connected to the battery will not be affected and may continue to discharge the battery.)
BATT1 Overheating	The controller can detect the battery temperature through an external temperature sensor. The controller stops working when its temperature exceeds 65 °C and restarts to work

	when its temperature is below 55 °C.
BATT1Low Temperature(Lithium Battery)	When the temperature detected by the optional temperature sensor is lower than the Low Temperature Protection Threshold (LTPT), the controller will stop charging and discharging automatically. When the detected temperature is higher than the LTPT, the controller will work automatically (The LTPT is 0 °C by default and can be set within 10 ~ -40 °C).
Controller Overheating	The controller can detect the temperature inside the controller. The controller stops working when its temperature exceeds 85 °C and restarts to work when its temperature is below 75 °C.
TVSHigh Voltage Transients	The internal circuitry of the controller is designed with Transient Voltage Suppressors (TVS), which can only protect against high-voltage surge pulses with less energy. Suppose the controller is to be used in an area with frequent lightning strikes. In that case, it is recommended to install an external surge arrester.

4.2 Troubleshooting

Faults phenomenon	Possible reasons	Troubleshooting
Charging LED indicator off during daytime when sunshine falls on PV modules properly	PV array disconnection	Confirm that PV wire connections are correct and tight.
The wire connection is correct, and the controller is not working.	Battery voltage is lower than 8.5V	Please check the battery voltage—at least 8.5V to activate the controller.
DDS:  Red fast flashing   Battery level shows full, battery frame blink, fault icon blink	BATT1over voltage	Check if the battery voltage is higher than OVD (over-voltage disconnect voltage), and disconnect the PV.

<p>DDB:  red on solid</p>	<p>BATT1over discharged</p>	<p>When the battery voltage is restored to or above LVR(low voltage reconnect voltage), the load will recover</p>
<p>DDS:  Battery level shows empty, battery frame blink, fault icon blink</p>		
<p>DDB:  Red fast flashing</p>	<p>BATT1 Overheating</p>	<p>The controller will automatically turn the system off. When the temperature declines to be below 55 °C, the controller will resume.</p>
<p>DDS: Battery level shows current capacity, battery frame blink, fault icon blink, the temperature icon blink, the temperature value blink, the temperature unit blink.</p> <p> </p> <p>Main </p>		
<p>DDS:  Red Fast flashing and  Green fast flashing</p> <p>Main </p>	<p>BATT1 System voltage error</p>	<p>①Check whether the battery voltage matches the controller's working voltage. ② Please change to a suitable battery or reset the working voltage.</p>
<p>① System voltage alarms when using the Lead-acid battery for the BATT1. ② System over-discharge alarms when the BATT1 is set as 24V battery type. Its actual voltage is 12V. ③ System over-voltage alarms when the BATT1 is set as 12V battery type. Its actual voltage is 24V.</p>	<p>Incorrect wiring--connect BATT1 first and then BATT2</p>	<p>① Disconnect the system, and reconnect the BATT2 first, then reconnect BATT1 ②③BATT1 voltage should be the same as the controller's voltage level</p>

4.3 Maintenance

The following inspections and maintenance tasks are recommended at least twice yearly for best controller performance.

- Make sure the controller is firmly installed in a clean and dry ambient.
- Make sure no block on airflow around the controller. Clear up any dirt and fragments on the radiator.
- Check all the naked wires to ensure insulation is not damaged by serious solarization, frictional wear, dryness, insects or rats, etc. Repair or replace some wires if necessary.
- Tighten all the terminals. Inspect for loose, broken, or burnt wire connections.
- Check and confirm that LED or LCD is consistent with the required. Pay attention to any troubleshooting or error indication. Take necessary corrective action.
- Confirm that all the system components are ground connected tightly and correctly.
- Confirm that all the terminals have no corrosion, insulation damage, high temperature, or burnt/discolored sign. Tighten terminal screws to the suggested torque.
- Clear up dirt, nesting insects, and corrosion in time.
- Check and confirm that the lightning arrester is in good condition. Replace a new one in time to avoid damaging the controller and other equipment.



Risk of electric shock!

Ensure all the power is turned off before the above operations and follow the corresponding inspections.

5 Specifications

Electrical Parameters

Item	DR1106N -DDB/DDS	DR2106N -DDB/DDS	DR3106N -DDB/DDS	DR1206N -DDB/DDS	DR2206N -DDB/DDS	DR3206N -DDB/DDS	DR2210N -DDB/DDS	DR3210N -DDB/DDS
BATT1 rated voltage	12VDC			12/24VDC				
BATT2 rated voltage	12VDC			12/24VDC Auto				
BATT1 Rated Charge Current	10A	20A	30A	10A	20A	30A	20A	30A
BATT2 Rated Charge Current	1A							
Battery Input Voltage Range ^①	8.5~16V			8.5~32V				
Max. PV Open Circuit Voltage	60V ^② 46V ^③					100V ^② 92V ^③		
MPP Voltage Range	(Battery Voltage+2V)~36V					(Battery Voltage+2V)~72V		
Rated Charge Power	130W/12V	260W/12V	390W/12V	130W/12V 260W/24V	260W/12V 520W/24V	390W/12V 780W/24V	260W/12V 520W/24V	390W/12V 780W/24V
Max. conversion efficiency	96.3%	96.9%	97.4%	97.4%	97.5%	98%	97.5%	98%
Full load efficiency	95.5%	94.6%	94.2%	97%	96%	96%	96%	96%

Self-consumption	12mA/12V; 6mA/12V (Low-power mode)	12mA/12V; 8mA/24V 4mA/12V; 3mA/24V(Low-power mode)	26mA/12V; 15mA/24V 19mA/12V; 10mA/24V (Low-power mode)
Temperature compensate coefficient ^④	-3mV/°C/2V(default)		
Grounding	Common negative		
BATT2 Full voltage	13.8V/12V	13.8V/12V; 27.6V/24V(default)	
BATT2 Charge return voltage	13V/12V	13V/12V; 26V/24V(default)	
AES signal port ^⑤	12VDC/Max.200mA(3.81-4P)	5VDC/Max.200mA(2*(3.81-4P))	
RS485 com. port ^⑤	5VDC/Max.200mA(3.81-4P)		
Com. baud rate ^⑥	115200(default)		
LCD backlight time ^⑦	60S(default)		

① When the lithium battery is 12V and the BMS is protected, the lithium battery voltage may rise to 17V(DR*106N) or 35V(DR*206N、DR*210N).

It may damage the load; please consider the load's voltage.

② At minimum operating environment temperature.

③ At 25°C environment temperature.

④ The Temperature compensate coefficient is zero and not changeable when the main battery type is a lithium battery.

⑤ AES port is 12V/200mA, and RS485 port is 5V/200mA are independent of DR1106/2106/3106N models, the AES port output voltage is the battery voltage. The above two ports of DR1206/2206/3206/2210/3210N models share the power of 5VDC/Max. 200mA

⑥ The communication baud rate can only be set via PC software.

⑦ The LCD backing time can only be set via PC software. The setting range is 0~999S, and the 0s means the LCD is ON all the time.

Environmental Parameters

Item	DR1106/2106/3106/1206/2206/2210N-DDB/DDS	DR3206/3210N-DDB/DDS
Environment temperature(100% input and output)	-20°C ~ +50°C(DDS) -30°C ~ +50°C(DDB)	-20°C ~ +45°C(DDS) -30°C ~ +45°C(DDB)
Storage temperature	-30°C ~ +80°C	
Relative humidity	≤95%, N.C	
Enclosure	IP33 3-protection against solid objects: protected against solid objects over 2.5mm. 3-protected against sprays to 60° from the vertical.	
Pollution degree	PD2	

Mechanical Parameters

Item	DR1106/1206N-DDB/DDS	DR2106/2206/2210N-DDB/DDS	DR3106/3206/3210N-DDB/DDS
Dimension (L x W x H)	227.2×143×58.1mm	243.7×158×63mm	247.2×165×68.5mm
Mounting size (L x W)	160×134mm	180×149mm	180×156mm
Mounting hole size	φ5mm		
Terminal	12AWG/4mm ² (BATT1) 12AWG/4mm ² (BATT2)	6AWG/16mm ² (BATT1) 12AWG/4mm ² (BATT2)	6AWG/16mm ² (BATT1) 12AWG/4mm ² (BATT2)
Recommended cable size	12AWG/4mm ² (BATT1) 12AWG/4mm ² (BATT2)	10AWG/6mm ² (BATT1) 12AWG/4mm ² (BATT2)	8AWG/10mm ² (BATT1) 12AWG/4mm ² (BATT2)
Weight	0.8kg	1.1kg	1.4kg

Annex I Dimension Diagrams

- DR1106/1206N-DDB/DDS (Unit: mm)

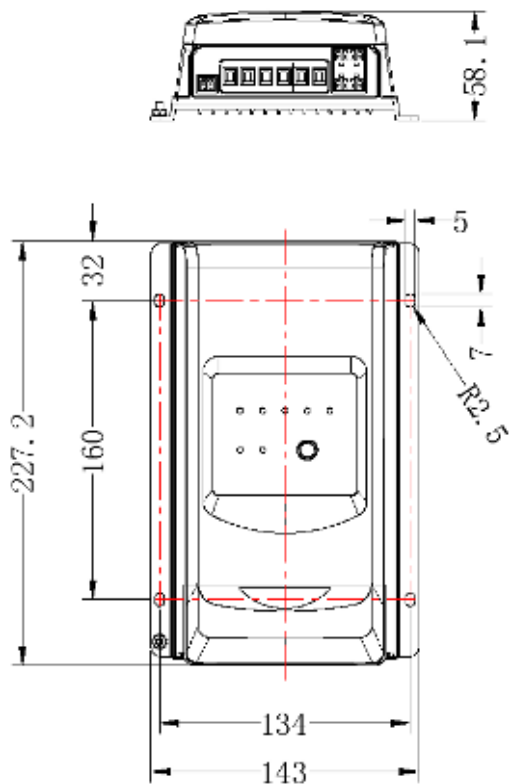

- DR2106/2206/2210N-DDB/DDS (Unit: mm)

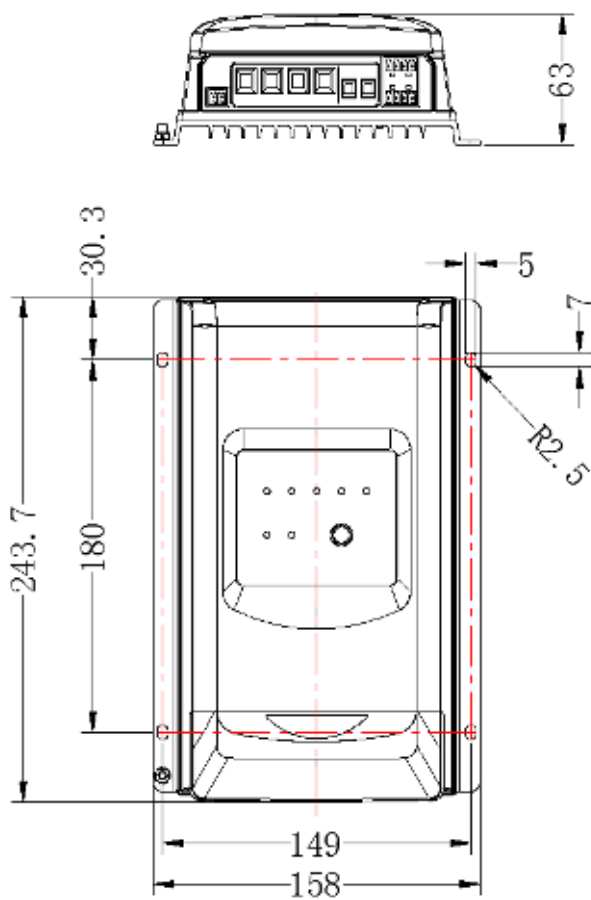

- DR3106/3206/3210N-DDB/DDS (Unit: mm)

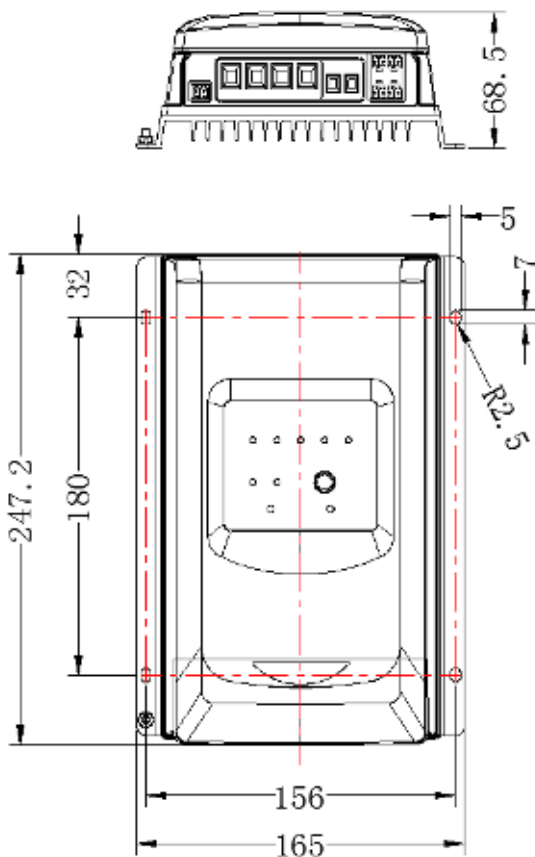

Any changes without prior notice!

Version number: 2.5

HUIZHOU EPEVER TECHNOLOGY CO., LTD.

Tel: +86-752-3889706

E-mail: info@epever.com

Website: www.epever.com